

MOUNTING AND INSTRUCTION MANUAL

DTS 4132.timeserver

Network – Time Server and Master Clock



Certification of the Producer

STANDARDS

The DTS 4132.timeserver was developed and produced in accordance with the EU Guidelines.

| | |
|----------------|---------|
| 2014 / 30 / EU | EMC |
| 2014 / 35 / EU | LVD |
| 2008 / 57 / EU | Railway |
| 2011 / 65 / EU | RoHS |
| 1907 / 2006 | REACH |



References to the Instruction Manual

1. The information in this Instruction Manual can be changed at any time without notice. The current version is available for download on www.mobatime.com.
2. The device software is continuously being optimized and supplemented with new options. For this reason, the newest software version can be obtained from the Mobatime website.
3. This Instruction Manual has been composed with the utmost care, in order to explain all details in respect of the operation of the product. Should you, nevertheless, have questions or discover errors in this Manual, please contact us.
4. We do not answer for direct or indirect damages, which could occur, when using this Manual.
5. Please read the instructions carefully and only start setting-up the product, after you have correctly understood all the information for the installation and operation.
6. The installation must only be carried out by skilled staff.
7. It is prohibited to reproduce, to store in a computer system or to transfer this publication in a way or another, even part of it. The copyright remains with all the rights with BÜRK MOBATIME GmbH, D-78026 VS-Schwenningen and MOSER-BAER AG – CH 3454 Sumiswald / SWITZERLAND.

Overview

| | | |
|----|---|----|
| 1 | Safety | 6 |
| 2 | Maintenance | 8 |
| 3 | General Information: Introduction..... | 9 |
| 4 | Displays | 12 |
| 5 | Installation | 14 |
| 6 | Operation..... | 15 |
| 7 | Updates | 62 |
| 8 | Time administration | 68 |
| 9 | SNMP | 75 |
| 10 | Description of the switch function..... | 79 |
| 11 | Power supply alternatives | 81 |

APPENDIX

| | | |
|---|-------------------------------------|-----|
| A | Connection diagrams..... | 82 |
| B | Time zone table | 86 |
| C | Alarm list..... | 88 |
| D | Troubleshooting | 90 |
| E | Serial Telegrams..... | 92 |
| F | Copyright Notice | 97 |
| G | Parameters | 98 |
| H | Technical data | 102 |
| I | Index..... | 105 |
| J | Connection table (to fill in) | 107 |

Table of contents

| | | | | |
|--------|---|----|--|----|
| 1 | Safety | 6 | 6.5.21 Alarm input | 51 |
| 1.1 | Safety instructions | 6 | 6.5.22 General settings | 52 |
| 1.2 | Symbols and Signal Words used in this Instruction Manual | 6 | 6.5.23 Network | 53 |
| 1.3 | Intended Use | 6 | 6.5.24 Services (network services FTP, telnet, SSH...) | 55 |
| 1.4 | Observe operating safety! | 7 | 6.5.25 SNMP | 56 |
| 1.5 | Consider the installation site! | 7 | 6.5.26 SNMP V1 / V2c | 57 |
| 1.6 | Please observe the electromagnetic compatibility! | 7 | 6.5.27 SNMP V3 | 58 |
| 1.7 | Network security | 7 | 6.5.28 Time zone selection | 60 |
| 2 | Maintenance | 8 | 6.6 Maintenance menu | 61 |
| 2.1 | Troubleshooting: Repairs | 8 | 7 Updates | 62 |
| 2.2 | Cleaning | 8 | 7.1 Updating images with MOBA-NMS | 62 |
| 2.3 | Disposing | 8 | 7.2 Updating images with FTP | 62 |
| 3 | General Information: Introduction | 9 | 7.3 Updating applications or configurations with FTP | 63 |
| 3.1 | Scope of Delivery | 9 | 7.4 Updating images via USB | 63 |
| 3.2 | Technical Data | 9 | 7.5 Updating applications or configurations via USB | 64 |
| 3.3 | Device Description in this Manual | 9 | 7.6 FTP connection | 65 |
| 3.4 | Introduction | 9 | 7.7 SFTP connection | 65 |
| 3.5 | Device types | 10 | 7.8 SCP connection | 66 |
| 3.6 | Distributed Time System | 10 | 7.9 Save Configuration externally | 66 |
| 3.7 | MOBA-NMS - Network Management System | 10 | 7.10 Copying Telegram or Program files to the DTS 4132.timeserver | 67 |
| 3.7.1 | Overview of the main functions | 11 | 8 Time administration | 68 |
| 3.7.2 | Device management | 11 | 8.1 Concept of time administration | 68 |
| 4 | Displays | 12 | 8.2 Time acceptance | 69 |
| 4.1 | LED displays front side | 12 | 8.3 Time acceptance from an external source (DCF or GPS) | 69 |
| 4.2 | LED indication back side | 12 | 8.4 Time acceptance from NTP | 70 |
| 4.3 | Display | 13 | 8.5 NTP as backup | 70 |
| 5 | Installation | 14 | 8.6 Time server | 70 |
| 5.1 | Connections | 14 | 8.7 Time accuracy, time-keeping | 70 |
| 5.2 | Boot procedure of the DTS 4132.timeserver | 14 | 8.8 Leap second | 71 |
| 5.3 | Initial configuration | 14 | 8.9 NTP Authentication | 71 |
| 5.4 | Firmware | 14 | 8.9.1 NTP symmetric keys | 71 |
| 5.5 | Basic settings (factory settings) | 14 | 8.9.2 NTP Autokey | 72 |
| 6 | Operation | 15 | 8.10 Redundant operation of 2 DTS 4132.timeservers | 73 |
| 6.1 | General | 15 | 9 SNMP | 75 |
| 6.1.1 | Serial connection | 16 | 9.1 General | 75 |
| 6.1.2 | Telnet | 16 | 9.2 Device configuration with SNMP | 76 |
| 6.1.3 | SSH | 16 | 9.3 DTS subagent SNMP notification | 76 |
| 6.1.4 | Menu structure | 17 | 9.3.1 Startup [dts4132StartUp] | 76 |
| 6.2 | MOBA-NMS operation | 18 | 9.3.2 Shutdown [dts4132Shutdown] | 76 |
| 6.3 | Main menu | 19 | 9.3.3 Status changed [dts4132StatusChanged] | 77 |
| 6.4 | Status menu | 20 | 9.3.4 Configuration changed [dts4132ConfigChanged] | 77 |
| 6.4.1 | Time information and status | 21 | 9.3.5 Alive Notification [dts4132Alive] | 78 |
| 6.4.2 | Time source information | 22 | 9.3.6 Alarm Notification [dts4132Alarm] | 78 |
| 6.5 | Configuration menu | 23 | 10 Description of the switch function | 79 |
| 6.5.1 | Outputs | 24 | 10.1 General Description | 79 |
| 6.5.2 | DCF – output | 24 | 10.2 Combination of the signals | 80 |
| 6.5.3 | DCF / Pulse / Frequency output | 25 | 10.3 Behavior at start-up, exchange of switch program file | 80 |
| 6.5.4 | Serial interface | 26 | 11 Power supply alternatives | 81 |
| 6.5.5 | NTP slave clocks / time zone server | 28 | | |
| 6.5.6 | MOBALine | 30 | | |
| 6.5.7 | Impulse line | 32 | | |
| 6.5.8 | DCF active code line | 33 | | |
| 6.5.9 | Switch function / Switch program | 35 | | |
| 6.5.10 | Time handling | 38 | | |
| 6.5.11 | Time source | 39 | | |
| 6.5.12 | Time adjustment / Time-keeping | 40 | | |
| 6.5.13 | Redundant operation | 41 | | |
| 6.5.14 | NTP server | 42 | | |
| 6.5.15 | Manual time set / Leap second | 46 | | |
| 6.5.16 | Alarms | 46 | | |
| 6.5.17 | Alarm relay | 47 | | |
| 6.5.18 | Alarm mask | 47 | | |
| 6.5.19 | E-mail | 48 | | |
| 6.5.20 | SNMP traps | 50 | | |

APPENDIX

| | | |
|-----|--|-----|
| A | Connection diagrams | 82 |
| A.1 | Front connections..... | 82 |
| A.2 | Connections (rear view) | 83 |
| A.3 | Plug-in spring terminals..... | 85 |
| A.4 | Connection GPS 4500, DCF 450 or GNSS 3000 | 85 |
| B | Time zone table | 86 |
| C | Alarm list | 88 |
| D | Troubleshooting | 90 |
| E | Serial Telegrams..... | 92 |
| E.1 | General | 92 |
| E.2 | Syntax of the telegram configuration file | 93 |
| F | Copyright Notice | 97 |
| G | Parameters | 98 |
| H | Technical data..... | 102 |
| I | Index | 105 |
| J | Connection table (to fill in) | 107 |

1 Safety



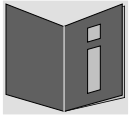

1.1 Safety instructions



Read this chapter and the entire instruction manual carefully and follow all instructions listed. This is your assurance for dependable operations and a long life of the device.

Keep this instruction manual in a safe place to have it handy every time you need it.

1.2 Symbols and Signal Words used in this Instruction Manual

| | |
|---|---|
|  | Danger! Please observe this safety message to avoid electrical shock! There is danger to life! |
|  | Warning! Please observe this safety message to avoid bodily harm and injuries! |
|  | Caution! Please observe this safety message to avoid damages to property and devices! |
|  | Notice! Additional information for the use of the device. |

1.3 Intended Use

The **DTS 4132.timeserver** is a time server for the use in network environments. It can be synchronized from NTP and be used as NTP server. In addition, it can read the time from DCF or GPS (e.g. from GPS 4500).

It can operate as master clock for self-setting MOBALine or impulse clock lines. The DTS 4132 has 2 such lines.

For additional functions, see the device descriptions in chapter 3.

The device is designed for 19" racks and intended to be installed in a 19" cabinet. Operate the device only in installed condition and with all connectors plugged in.

Use this product only as stated in this instruction manual. Any other use is considered improper use.



Caution!

1.4 Observe operating safety!

- Never open the housing of the device! This could cause an electric short or even a fire, which would damage your device. Do not modify your device!
- The device is not intended for use by persons (including children) with limited physical, sensory, or mental capacities or a lack of experience and/or knowledge.
- Keep packaging such as plastic films away from children. There is the risk of suffocation if misused.



Caution!

1.5 Consider the installation site!

- To avoid any operating problems, keep the device away from moisture and avoid dust, heat, and direct sunlight. Do not use the device outdoors.
- The device is designed for 19" racks and should only be operated installed in a 19" cabinet.



Danger! Make sure

that you wait before using the device after any transport until the device has reached the ambient air temperature. Great fluctuations in temperature or humidity may lead to moisture within the device caused by condensation, which can cause a short.



Caution!

1.6 Please observe the electromagnetic compatibility!

- This device complies with the requirements of the EMC and the Low-voltage Directive.



Caution!

1.7 Network security

- The default password shall be changed after the commissioning of the device.
- A reset of the password to default through hardware is not possible. Using MOBA-NMS the password can be modified. In case an access via MOBA-NMS is not possible, support effort will be needed or the device has to be sent back to the factory.
- All unused services shall be deactivated: FTP, Telnet,...

2 Maintenance

2.1 Troubleshooting: Repairs

Please read carefully Appendix D Troubleshooting if your device does not work properly.

If you cannot rectify the problems, contact your supplier from whom you have purchased the device.

Any repairs must be carried out at the manufacturer's plant.

Disconnect the power supply immediately and contact your supplier if ...

- liquid has entered your device.
- the device does not properly work and you cannot rectify this problem yourself.

2.2 Cleaning

- Please make sure that the device remains clean especially in the area of the connections, the control elements, and the display elements.
- Clean your device with a damp cloth only.
- Do not use solvents, caustic, or gaseous cleaning substances.

2.3 Disposing



Device

At the end of its lifecycle, do not dispose of your device in the regular household rubbish. Return your device to your supplier who will dispose of it correctly.



Packaging

Your device is packaged to protect it from damages during transport.

Packaging is made of materials that can be disposed of in an environmentally friendly manner and properly recycled.

3 General Information: Introduction

3.1 Scope of Delivery

Please check your delivery for completeness and notify your supplier within 14 days upon receipt of the shipment if it is incomplete.

The package you received contains:

- DTS 4132.timeserver
- Mounting set for rack mounting consisting of:
 - 4 pcs nuts for 19" housing
 - 4 screws M6 for the nuts
 - 4 plastic discs for screws M6
- Connector set
 - 2 * spring terminal 2-pole orange
 - 2 * spring terminal 4-pole orange
 - 3 * spring terminal 5-pole orange
 - 1 * spring terminal 6-pole orange
- 2 pcs mounting tools with spring terminals

3.2 Technical Data

See Appendix "H Technical data".

3.3 Device Description in this Manual

This instruction manual is for the master clock **DTS 4132.timeserver**. In the following chapters, the designations **DTS 4132** or simply **time server** are used for better readability.

3.4 Introduction

The DTS 4132.timeserver is a NTP Time Server for use in network environments. It can be synchronized by DCF or GPS (e.g. from GPS 4500) and NTP, and act as a NTP server in a network.

It can be used as a master clock for NTP slave clocks, synchronized via unicast or multicast with NTP and time zone table.

It is equipped with 2 LAN interfaces for the operation in two independent networks.

In addition, the DTS 4132 provides two serial MOBALine interfaces for the output of time telegrams as well as an output line for technical impulses (impulse/frequency/DCF).

As the "main" master clock, the DTS 4132 can synchronize other master clocks or other equipment with DCF and monitor with 1 alarm input.

The DTS 4132 can send both e-mails and SNMP traps for alerting purposes.

Using MOBA-NMS and SNMP, the DTS 4132 can be fully operated and its configuration and system status can be requested.

To maintain a redundant time source, two DTS 4132 can be linked by an optical link.

3.5 Device types

| Model: | Features: | Product no.: |
|---------------------|---|--------------|
| DTS 4132.timeserver | According to above description with TCXO (temperature compensated quartz) | 118968 |

3.6 Distributed Time System

The Distributed Time System is a system developed by Moser-Baer AG to connect decentralized master clocks, slave clock lines and time servers. For communication, standard LAN (Ethernet) is used. It can be centrally operated and monitored.

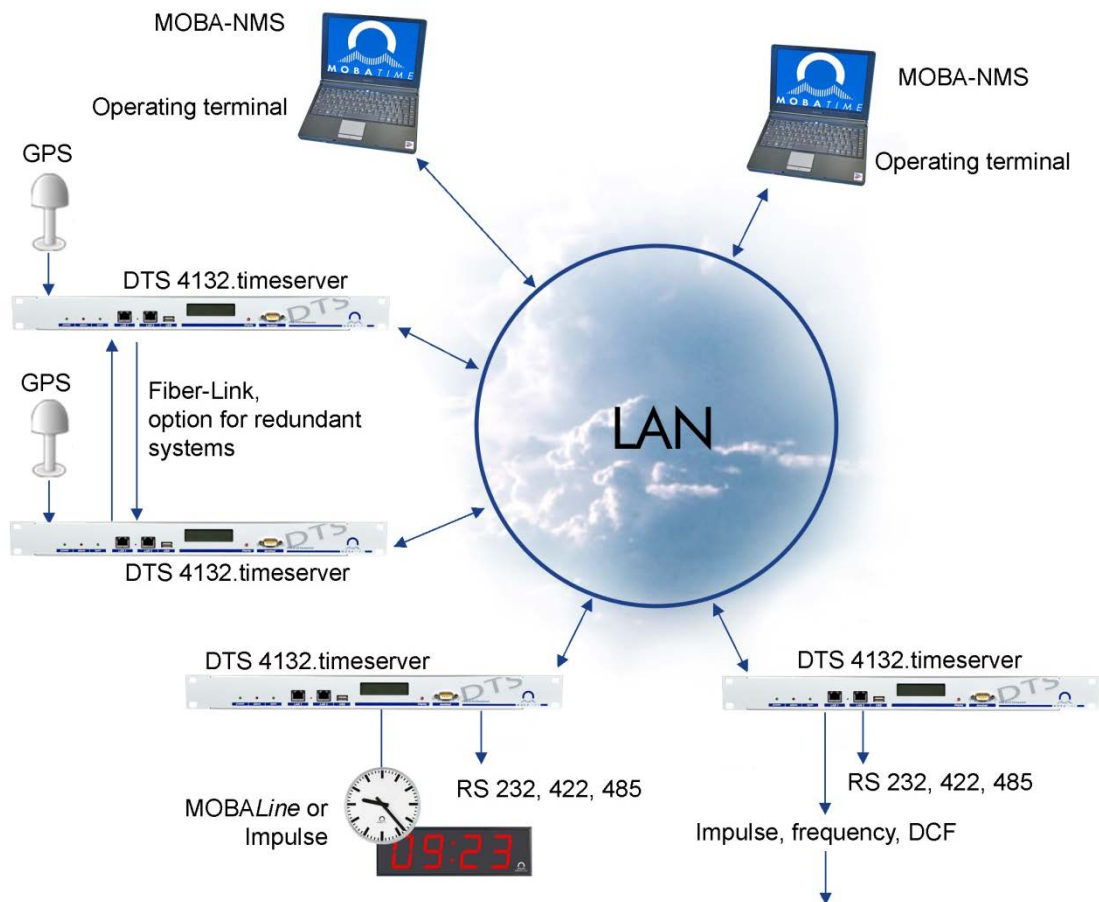

3.7 MOBA-NMS - Network Management System

MOBA-NMS is software used for central management and inquiry of state and alarm information. It supports DTS devices as well as all MOBATIME analog and digital network clocks and can handle a network with more than 1000 devices. This software provides extensive functions for the configuration, installation, back-up / recovery etc. especially for DTS devices.

Due to the distributed time system concept, MOBA-NMS can be installed multiple times in one network. With different user rights on the device and software level, the configuration abilities of different users can be set as required.

For DTS devices, all communication is conducted over SNMP V3. The SFTP protocol is used for broadcasting files.

3.7.1 Overview of the main functions

The main MOBA-NMS functions for DTS devices and network clocks are listed below:

- automatic device scan over multicast or IP range
- device management using user-defined device groups → see chapter „3.7.2 Device management“
- intuitive user interface with input check for the device configuration
- status / alarm request and display on the device group level
- device firmware update for one or several devices (parallel)
- support for device commands, e. g. reset, restart etc.
- back-up / recovery of DTS devices
- transfer of the whole DTS configuration to another device
- user management with different access rights
- monitor for NTP and time zone packages
- editor for time zone files
- online help
- etc.

3.7.2 Device management

All MOBATIME network devices are displayed in the so-called device view. Here, the devices can be grouped according to user-defined criteria. For this, the individual devices can simply be moved to the according groups and sorted using drag and drop. There is no limit to the number of groups and sub-groups.

Besides the organizational advantages (easier locating, better overview), a device group has the following advantages:

- commands and device updates can be applied to the whole group (including sub-groups).
- Alarms and errors of included devices are displayed on the group level.
- Complete groups can be moved / sorted among themselves.

The content of the device view can be saved and opened at a later time. The created structure and breakdown into groups is preserved.

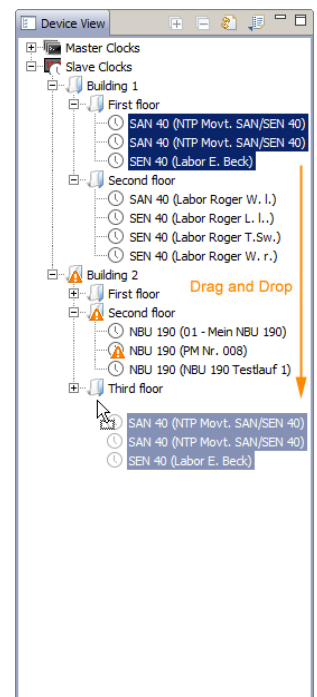

4 Displays

4.1 LED displays front side

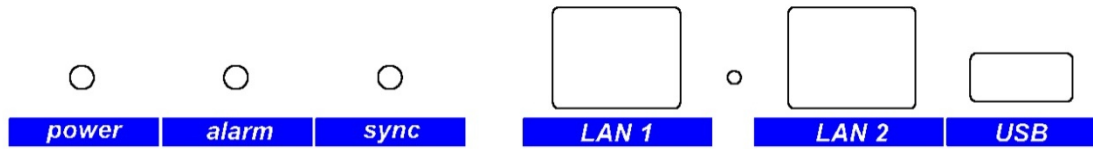

| Description | Color | Status | Description |
|----------------------|-----------------|----------------------|---|
| Power | Green | On Off | Mains or DC power supply is in order No power supply |
| Alarm | Red | On Off | The alarm relay signals an alarm No active alarms |
| Sync | Green | On Off | DTS 4132 can read the time from a synchronization source Synchronization source is not available |
| LAN 1 control lamps: | | | |
| Left | Green Orange | Blinking Blinking | Network activity No connection to network |
| Right | Yellow | Off On | 10 Mbit 100 Mbit |
| LAN 2 control lamps: | | | |
| Left | Green Orange | Blinking Blinking | Network activity No connection to network |
| Right | Yellow | Off On | 10 Mbit 100 Mbit |

4.2 LED indication back side

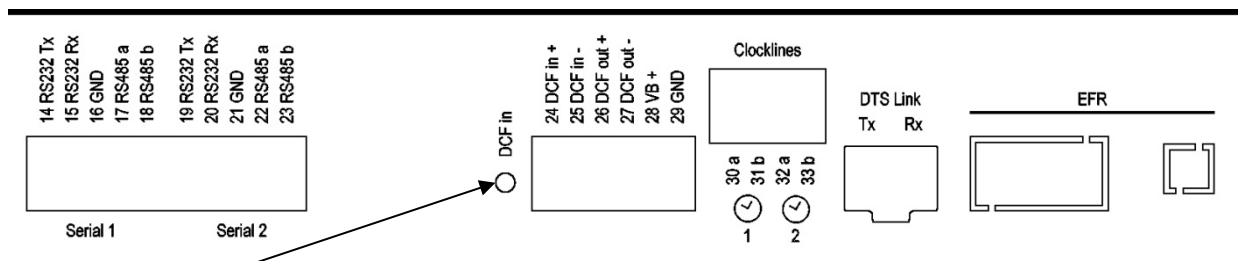

| Description | Color | Status | Description |
|-------------|-------|----------|---|
| DCF in | red | Blinking | DCF (GPS reception), blinking every second → time information from receiver |

4.3 Display

Display showing the current status of the DTS 4132.

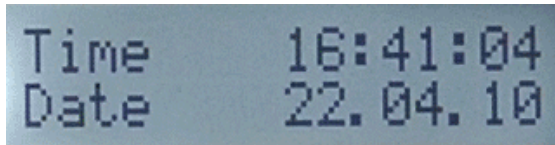

Display of:

- Time, date
- Current time source
- Stratum of the DTS 4132, status: Master / Slave
- Software version
- IPv4 address LAN 1
- IPv4 address LAN 2
- IPv6 address LAN 1
- IPv6 address LAN 2
- Alarm summary
- Current alarms

The display can be operated by means of the corresponding “Display“ button:

First brief push of the button: Switch on the background light
Repeated brief pushes of the button: Scroll through all displays
Press button longer (>3 sec): Change to default display (time and date)

The display changes after approx. 3 min without pressing the button for the default display and the background light goes off.

If a USB stick has been plugged in, it will be displayed. If only telegram files should be copied or the network settings should be changed, this can be activated directly with the button. (Press the button until the copy process starts).

5 Installation

5.1 Connections

The connections are specified in Appendix "A Connection diagrams".

Only connect the designated devices to the various inputs and outputs.

5.2 Boot procedure of the DTS 4132.timeserver

The normal booting time of the DTS 4132 is approx. 60 sec. with pre-set IP or with DHCP. The booting procedure of the operating system is displayed on the serial console. After that, the text "starting" appears on the display (during the booting procedure the display is dark and empty). Without connection to a DHCP server, the first start up can take up to 75 seconds. After that, the DHCP option must be set to "off" in the network configuration.

The display "starting" remains until the time of output to the lines.

The duration, depending on the configuration, is 5-30 sec.

5.3 Initial configuration

Per default, the LAN 1 interface is configured with DHCP on. After booting in a network with DHCP server, the received IP address can be displayed.

The LAN 2 interface is configured with the following static settings per default:
IP 192.168.1.5, Subnet 255.255.255.0, Gateway 192.168.1.1

If these possibilities do not work out for the initial configuration, the network configuration can be modified using a USB stick. For this purpose, a text file named **DTS4132NW.conf** is created and filled with the corresponding parameters (not all parameters are required):

```
IP1:192.168.1.3  
SUB1:255.255.255.0  
GW1:192.168.1.1  
IP2:10.0.0.7  
SUB2:255.255.240.0  
GW2:10.0.0.1
```

The insertion of the USB stick is displayed. For taking over the network settings, press the button until the normal time display reappears.

5.4 Firmware

It is recommended to install the current firmware on your device prior to the definite commissioning. The current firmware can be found under www.mobatime.com → *Customer Data* → *Product Resources* → *Time Server*.

5.5 Basic settings (factory settings)

The basic settings can be found in the table in Appendix "G Parameters".

6 Operation

6.1 General

Operation occurs via a terminal menu or SNMP. SNMP operation is explained in chapter "9 SNMP". Operation with the terminal menu takes place either via Telnet or SSH. After a connection has been set up, the login screen is displayed:



To start the menu, *DTS* must be logged in as user. The standard password is *DTS*. (Changing the password → see chapter "6.5.22 General settings").

Only one menu can be open at any time. The first menu started has priority. The menu is automatically closed after 15 min. without operation, and any possible connection via Telnet or SSH is interrupted.

Backspace:

Backspace must be set to "delete" with the serial terminal.

Local echo:

Some terminals (serial or Telnet) do not display the characters entered. It is, therefore, necessary to switch on the "local echo" in the terminal.

6.1.1 Serial connection

38400 Bauds, 8 data bits, no parity, 1 stop bit.

Windows XP, 7, 8, 10: Putty

Linux: Minicom

Switch off Xon/Xoff and hardware handshake.

After establishing the serial connection, the menu can be initialized with ENTER.
When rebooting, the boot process will be displayed on the serial console.



Warning: The serial connection should always be disconnected before switching off the operating PC (exit terminal program or pull out the RS232 plug).

6.1.2 Telnet

Windows XP, 7, 8, 10: Start → Run → *telnet [IP address]* or Putty
User: *dts*
Password: standard password *dts*
NetTerm (Shareware)

Linux: Start console and enter "*telnet [IP address]*"

6.1.3 SSH

Windows XP, 7, 8, 10: e.g. with Putty

Linux: Start console and enter "*ssh dts@[IP-address]*"
Password: **dts**

6.1.4 Menu structure

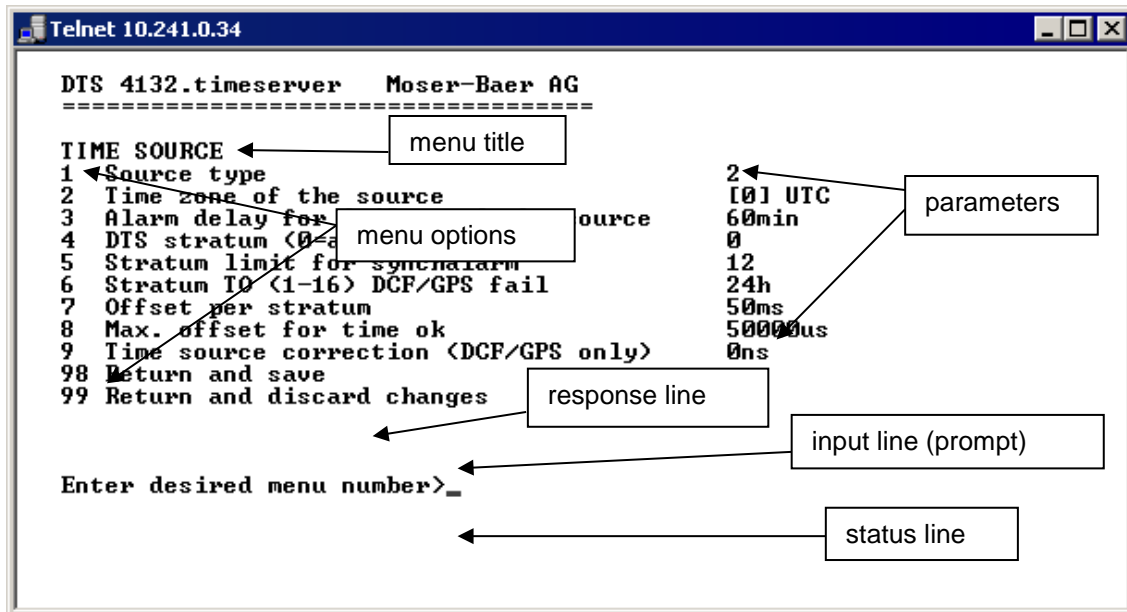

The current menu is always displayed in the **menu title**. The **menu options** show all the selectable menu functions. Provided the menu item is not a further menu, the set **parameters** are displayed. Error messages (e.g. invalid entries) or additional information to the selected menu items are displayed in the **response line**. The **input line** shows the current input values or options possible. The **status line** only appears, when an information has to be displayed, e.g. "An alarm is active".

All entries must be completed with ENTER (Return) (e.g. also ESC).

The menu window can always be exited with *Ctrl-C* (incl. termination of the Telnet and SSH connection).

The desired menu can be selected with the relevant number.

The numbers 98 and 99 are always used identically:

- With 98, the settings entered are saved and the menu exited. Depending on the change, the DTS 4132, or only partial functions, are rebooted.
- With 99, all changes to the menu are reversed and the menu exited.
In the menus where data cannot be saved (command 98), the menu is only exited with 99, but any changes are not saved.

The current menu is updated, without any further entry, with ENTER.

6.2 MOBA-NMS operation

For the configuration of DTS devices via GUI, MOBA-NMS (see chapter „3.7 MOBA-NMS - Network Management System“) can be used. All configuration possibilities are subordinated in different configuration pages (called „tabs“). These tabs are connected to the terminal menu and designated accordingly. Example: The terminal menu „Configuration → Alarms“ can be found in MOBA-NMS under the tab „Alarms“.

Configuration example of a DTS 4132.timeserver:

The screenshot displays the MOBA-NMS GUI for a DTS 4132 device. The interface is organized into several panels and tabs. At the top, the device name 'DTS 4132' and status 'Status: OK' are shown, along with the firmware version '00230115.010000.020000'. Below this, there are several main sections: 'List of active alarms' (currently empty), 'Network' (with sub-tabs for Interface 1 and Interface 2, showing IPv4 settings like IP-Address: 10.241.0.34), 'Power' (with sub-tabs for Power supply and Quartz correction, showing Voltage supply 1 [V]: 27.7), 'Time, time state' (showing Internal time (UTC): Jan 29, 2015 9:55:23 AM), 'Source' (with sub-tabs for Local and NTP, showing Actual measured offset: 0s 0us), 'NTP state' (with a link 'Show NTP status details...'), and 'State of the lines' (with sub-tabs for Line 1 and Line 2, showing State: Run). At the bottom, there is a navigation bar with tabs: Overview, Outputs, Switching functions, Time handling, Alarms, Network, SNMP, General, Services. A 'Refresh' button and 'Next refresh: 2 min. 13 sec.' are also visible.

configuration pages
(tabs)

For further details on the general MOBA-NMS operation, check the integrated online help (menu „Help → Show help“).

Important: To enable the communication between MOBA-NMS and the DTS devices, SNMP must be activated! Set terminal menu „Configuration → SNMP → SNMP Mode“ to „on“. SNMP is activated by default.



6.3 Main menu

```
DTS 4132.timeserver  Moser-Baer AG
=====

MAIN SELECTION
1  Status
   (Actual alarms and history, timesource state, version)
2  Configuration
   (Configuration of the lines, timesources, alarms ...)
3  Maintenance
   (Update, backup ...)

99 Exit DTS menu

Enter desired menu number>
```

Menus:

- Status: Display of various information regarding operation and environment
See chapter "6.4 Status menu"
- Configuration: Configuration of the DTS 4132
See chapter "6.5 Configuration menu"
- Maintenance: Software update, backup and restore
See chapter "6.6 Maintenance menu"

6.4 Status menu

The status menu consists of 2 pages.

Status menu page 1:

```
DTS 4132.timeserver  Moser-Baer AG
=====

CLOCK STATE                               Page 1
1 Alarm state
2 Alarm history
3 Time, time state
4 Local source
5 Power
6 Info network config.
7 Internal state
8 Product information
9 Versions of the software

Press enter for next part, 99 to leave>
```

Path: 1 Status

The menu shows various information on the current operating status.

1. Requesting alarm status, display of all the DTS 4132 active errors.
Display of the DTS 4132 alarms (64) on 4 pages. The ALARM DETAIL menu pages can be scrolled through with ENTER. Active alarms are displayed with a *. The ALARM DETAIL menu page can be exited with 99. All DTS 4132 active alarms are displayed, masking (e-mail, traps, relay) only occurs later.
2. Alarm history display.
Display of the DTS 4132 alarm record, newest alarm first. The ALARM RECORD menu pages can be scrolled through with ENTER. The ALARM RECORD menu page can be exited with ESC.
Max. length of error report: 240 messages.
3. Current time and status display. See chapter "6.4.1 Time information and status"
4. Time source information display. See chapter "6.4.2 Time source information"
5. Power supply information (current, voltage) display.
6. Current network configuration display. With ENTER, a second page can be displayed with network information.
7. DTS 4132 system information display (internal status, regulation voltage of the quartz..). This information is for support purposes only.
8. Product information like serial number, firmware version etc.
9. All respective software versions of the DTS 4132 components.

Status menu page 2:

```
DTS 4132.timeserver Moser-Baer AG
=====

CLOCK STATE                               Page 2
11 NTP peer state (ntpq -np)
12 NTP state (ntpq -c r1)
13 State of the lines

Press enter for next part, 99 to leave>
```

Display of information with regard to the internal state of the NTP server.

6.4.1 Time information and status

```
DTS 4132.timeserver Moser-Baer AG
=====

TIME INFORMATION AND STATUS
Internal time of the DTS (local time)      10:11:47 26.01.15
Stratum and state of DTS                   1 MASTER
Last measured drift                        0.0006ppm
Last quartz correction                     08:07:46 26.01.15 UTC
Time source                               GPS (DCF)
Offset to source                           0.0us
Last time information from source          09:11:44 26.01.15 UTC
Jitter of the source                       0.1us
Quality of the source                       100%

99 Return

Enter desired menu number>
```

Path: 1 Status → 3 Time, time state

- Internal time of the DTS: local time
- Stratum and status of the DTS: current stratum,
status: MASTER, SLAVE, not defined
- Last measured drift: drift before the last quartz correction
- Last quartz correction: time of the last quartz correction
- Time source: current time source
- Offset to source: offset to source (source – system time)
- Last time info. from source: time of the last information from source
- Jitter of the source: current jitter
- Quality of the source: quality of the source

6.4.2 Time source information

```

DTS 4132.timeserver  Moser-Baer AG
=====

TIMESOURCE INFORMATION
Actual measured offset          0us GPS FULL
Last time received DCF (UTC)   09:12:00 26.01.15 (0)
Sec. counter DCF               46
Last time received link (UTC) 00:00:00 01.01.70
Sec. counter link              0
NTP source                     Antenna (DCF/GPS)
NTP source offset              0us
NTP source jitter              1us
NTP source stratum             0

99 Return

Enter desired menu number>

```

Path: 1 Status → 4 Local source

- Currently measured offset: last measured offset with source info and type of measurement (only needed for Moser-Baer support).
- Last time received DCF: last time received from DCF source
In (): Information about number of available satellites (only for GPS 4500 and GNSS 3000). For DCF, this value is random.
- Sec. counter DCF: the counter is incremented by 1 with each DCF pulse. For the minute marker, the counter is set to 0.
- Last time received link: last time received from DTS Link
- Sec. counter link: analogue sec. counter DCF
- NTP – Source: current time source (system-peer) of the NTP Server
Antenna = DCF or GPS
- NTP source offset: current offset of the NTP Server
- NTP source jitter: jitter of the current source
- NTP source stratum: stratum of the current source

6.5 Configuration menu

```
DTS 4132.timeserver Moser-Baer AG
=====

CONFIGURATION
1  Outputs
2  Time handling
3  Alarms
4  General
5  Network
6  Services (FTP, telnet, SSH)
7  SNMP

99 Return

Enter desired menu number>
```

Path: 2 Configuration

Configuring the DTS 4132 through various submenus:

1. Configuring the lines / outputs (DCF/pulse/frequency, serial interfaces and NTP slave clock line) See chapter "6.5.1 Outputs"
2. Configuring the time source, time-keeping etc.
See chapter "6.5.10 Time handling"
3. Alarm settings (alarm relay, e-mail, SNMP)
See chapter "6.5.16 Alarm"
4. General settings of the DTS 4132 (language, time zone for alarms and display, password for menu, power supply monitoring...)
See chapter "6.5.22 General settings"
5. Network Settings
See chapter "6.5.23 Network"
6. Services (switching network services such as FTP, Telnet, SSH on or off)
See chapter "6.5.24 Services (network services FTP, telnet, SSH...)"
7. SNMP Configuration for GET/PUT.
See chapter "6.5.25 SNMP" (Traps are described in menu '2. Configuration' → '3. Alarms' → '3. Traps'. See also chapter "6.5.20 SNMP traps")

6.5.1 Outputs

Under outputs, settings can be undertaken for the following functions:

- | | | |
|---|-------------------------------------|---------------------|
| 1 | DCF - Output | → see chapter 6.5.2 |
| 2 | DCF / Pulse / Frequency output | → see chapter 6.5.3 |
| 3 | Serial Interface 1 | → see chapter 6.5.4 |
| 4 | Serial Interface 2 | → see chapter 6.5.4 |
| 5 | NTP slave clocks / time zone server | → see chapter 6.5.5 |
| 6 | MOBALine | → see chapter 6.5.6 |
| | / Impulse clock line 1 | → see chapter 6.5.7 |
| | / DCF active code line 1 | → see chapter 6.5.8 |
| 7 | MOBALine | → see chapter 6.5.6 |
| | / Impulse clock line 2 | → see chapter 6.5.7 |
| | / DCF active code line 2 | → see chapter 6.5.8 |

6.5.2 DCF – output

The DTS 4132 is equipped with one DCF output line.

This line is available on the electrical current loop DCF output.

```
DTS 4132.timeserver Moser-Baer AG
=====

DCF OUTPUT
1 Mode (0=off, 1=DCF)           1
2 Time zone                     [0] UTC

98 Return and save
99 Return and discard changes

Enter desired menu number>
```

Path: 2 Configuration → 1 Outputs → 1 DCF main out

1. Select line function: off or DCF on
2. Select time zone → see chapter 6.5.28 Time zone selection.

6.5.3 DCF / Pulse / Frequency output

```
DTS 4132.timeserver Moser-Baer AG
=====

DCF / PULSE / FREQUENCY OUTPUT 1
1 Mode (0=off, 1=DCF, 2=pulse, 3=frequency) 0
2 Time zone [0] UTC
3 Pulse type (0=sec 1=min 2=hour 3=user) 0
4 Pulse length 100ms
5 User defined pulse type 1sec
6 Correction of output 0ms
7 Frequency 1000Hz

98 Return and save
99 Return and discard changes

Enter desired menu number>
```

Path: 2 Configuration → 1 Outputs → 2 DCF / pulse / frequency out 1

1. Select line function: Line switched off, line DCF output, line pulse output, line frequency output
2. Select time zone → see chapter 6.5.28 Time zone selection.
3. Select pulse mode: every second, minute, hour or user-defined.
(Only active with the pulse output function)
4. Select pulse length in ms (1-500ms)
(Only active with the pulse output function)
5. User-defined pulse interval (1-3600 sec) only active with pulse type 3 (=user) (the value is also only then displayed). The pulse always occurs after a multiple of the pulse interval from the 0 second in the 0 minute, e.g.:
 - Pulse interval 960 sec. (16 min.)
→ Pulse occurs: 00:00:00, 00:16:00, 00:32:00, 00:48:00, 01:00:00, 01:16:00 ...
 - Pulse interval 25sec
→ Pulse occurs: 00:00:00, 00:00:25, 00:00:50, 00:01:15, 00:01:40, 00:02:05 ...
... 00:59:35, 01:00:00, 01:00:25 ...
6. Output correction (-500ms...+500ms)
7. Frequency (1 Hz ... 5 MHz)



Important: Only frequencies which fulfill the following requirements are to be used, otherwise, phase shifts occur:
 $20'000'000 / \text{frequency} = \text{whole number value}$

Important: Frequencies above 2 MHz are not sent out as a square-wave signal anymore.

6.5.4 Serial interface

Serial telegram output via RS232, RS422 or RS485.

```
DTS 4132.timeserver Moser-Baer AG
=====

SERIAL OUTPUT 1
1 Mode (0=off, 1=on)                0
2 Time zone
3 Com Mode
4 Baudrate
5 Databit
6 Stopbit
7 Parity
8 Telegram file

98 Return and save
99 Return and discard changes

Enter desired menu number>
```

Path: 2 Configuration → 1 Outputs → 3 Serial line 1 / 4 Serial line 2

1. Select mode: Line switched off / on
2. Select time zone → see chapter 6.5.28 Time zone selection.
3. Com mode:
 - 1 = send RS 232 (receive is not enabled)
 - 2 = send and receive RS232
 - 3 = send and receive RS485
 - 4 = send RS 422 (receive is not enabled)
4. Baudrate: 300, 600, 1200, 2400, 4800, 9600, 19200, 38400
5. Data bit: 7 or 8
6. Stop bit: 1 or 2
7. Parity: none, even, odd
8. Selecting telegram file changes to the menu "SELECTION OF FILE"



Notice: To set the parameters, the line type has to be selected first.

Notice: No flow control available.

The description of the telegram function and the telegram file can be found in Appendix E Serial Telegrams.

Selection of the telegram file:

```
DTS 4132.timeserver Moser-Baer AG
```

```
=====
```

```
SELECTION OF FILE
```

```
Page 1
```

```
00: MC482STD.TEL
```

```
01: MC482UTC.TEL
```

```
Enter requested file number
```

```
Press enter for next part, ESC to leave>
```

Path: 2 Configuration → 1 Outputs → 3/4 Serial line 1/2 → 8 Telegram file

The copy procedure of telegram files is explained in chapter "7.10 Copying Telegram or Program files to the DTS 4132.timeserver".

6.5.5 NTP slave clocks / time zone server

NTP slave clock line for operating slave clocks on the LAN (Ethernet). With this clock line, a world time function can be realized.

```
DTS 4132.timeserver Moser-Baer AG
=====

NTP SLAVE CLOCKS AND TIME ZONE SERVER
1 Mode(0=off 1=NTP 2=NTP+TZ 3=TZ 4=TZ poll) 0
2 Multicast address
3 Multicast port 65534
4 Pollinterval for NTP 0
5 Packet time to live (hops) 1
6 Repeat time to send TZ-tables (sec) 60
7 Delay time between packets (sec) 1
8 Configure time zone table

98 Return and save
99 Return and discard changes

Enter desired menu number>
```

Path: 2 Configuration → 1 Outputs → 5 NTP slave clocks / time zone server

1. Mode of clock line: 0 = off, 1 = Send NTP multicast, 2 = Send NTP multicast and time zone table, 3 = Send time zone table, 4 = Time zones on request, 5 (only for maintenance) = Send an empty time zone table and return to previous mode.
2. Multicast address for NTP and time zone server: **239.192.54.x**
Group address: x = 1-15 for MOBATIME devices, e.g. NCI, SEN 40.
3. Multicast port for Time zone server (enter an arbitrary value, empty is not allowed! Value e.g.: 65534). The port is also needed for requesting time zone entries (mode 4).
4. Poll-interval for NTP Multicast in 2^{poll-values} in seconds (range: 1 – 16).
E.g. poll-value = 2 → interval: 2² = 4 sec., poll-value = 5 → interval: 2⁵ = 32 sec.
For redundant Multicast time servers see remark next page.
5. Packet time to Live (TTL) for NTP- and time-zone-Multicast-packets in hops.
(Number of Routers in a network to transfer the packets through; for simple network without routing, enter value "1", for 1 Router enter "2").
6. Repeat time to send time zone table: 10 – 86400 sec.
7. Delay time between the sending of the individual time zone entries (one entry per Multicast packet) of the table: 1 – 60 sec.
8. Configuration of individual time zone entries. Displays menu "TIME ZONE TABLE".



Notice: Changes of multicast address, poll interval and TLL lead to a **restart** of the NTP server.

Notice: For the operation of a **multicast** communication (NTP and Time Zone Server) **the configuration of a gateway is required** (see chapter "6.5.23 Network"). The gateway can be set manually or by using DHCP.
If there's no gateway available, it's possible to set the own IP as gateway.



Notice: Redundant Multicast time server:

If two NTP servers in the same network should send NTP with the same Multicast IP address (redundancy), then the first time server has to be configured with a small **pollinterval** (e.g. 2 → 4 sec.) and second time server with a large pollinterval (min. 100 x larger, e.g. 9 → 512 seconds). As long as the first time server is sending NTP Multicast packets, the packets from second time server are ignored. This configuration is needed, to reach a defined situation for the end devices (the DTS with the more frequently NTP send rate gets higher priority for time reception).

Time zone table for the NTP slave clock line:

```
DTS 4132.timeserver Moser-Baer AG
=====

TIME ZONE - TABLE
Zone01: -1 Unknown season      Zone02: -1 Unknown season
Zone03: -1 Unknown season      Zone04: -1 Unknown season
Zone05: -1 Unknown season      Zone06: -1 Unknown season
Zone07: -1 Unknown season      Zone08: -1 Unknown season
Zone09: -1 Unknown season      Zone10: -1 Unknown season
Zone11: -1 Unknown season      Zone12: -1 Unknown season
Zone13: -1 Unknown season      Zone14: -1 Unknown season
Zone15: -1 Unknown season

Enter requested entry

Press enter for next part, 99 to leave>
```

Path: 2 Configuration → 1 Outputs → 5 NTP slave clocks / time zone server → 8 Configure time zone table

Display of all time zone entries (15) of time zone servers for NTP slave clock lines.

Choose a zone number to change selected zone.

Time zone selection → see chapter “6.5.28 Time zone selection“.

The page can be exited with 99. Changes are first stored or reset on the overlying menu page.

6.5.6 MOBALine

MOBALine clock line with switch function for clock illumination, switch program and world time function. Display of line 1 or 2

```
DTS 4132.timeserver Moser-Baer AG
=====

MOBALine                               1
1 Line type                             MBL
2 Line                                  on
3 Linemode (min)                         min
4 Linemode (sec)                         jump
5 Time zone                              [+1] Brussel
6 Max. current                           500mA
7 Switching function                     off
8 World time function                    off
9 Configure time zone table (world time)
98 Return and save
99 Return and discard changes

Enter desired menu number>
```

Path: 2 Configuration → 1 Outputs → 6/7 MOBALine / impulse line 1/2

1. Select line type: 0 = MOBALine, 1 = Impulse line, 2 = DCF active code line
2. Select line function: Line switched off, line switched on, let clocks run to 12:00.
3. Select MOBALine mode (minute hand): Minute steps, 30 second steps or cont. (10 sec. steps)
4. Select MOBALine mode (second hand): Jump, continuous with stop, continuous, wobbling with stop
5. Select time zone (see chapter “6.5.28 Time zone selection“)
6. Select maximum current (0-700mA) on the line. The line will be switched off for as long as the overcurrent is connected.
The maximum current is divided between both lines, i.e. it can always only be the remainder at the most that can be set as the maximum amount.
7. Switch function on or off
8. World time function on or off
9. Configure time zone table for world time

Important: Changes can only be undertaken when the clock line is switched off!



Time zone table for the world time function:

```
DTS 4132.timeserver Moser-Baer AG
=====
```

TIME ZONE - TABLE

| | |
|---------------------------|---------------------------|
| Zone01: -1 Not configured | Zone02: -1 Not configured |
| Zone03: -1 Not configured | Zone04: -1 Not configured |
| Zone05: -1 Not configured | Zone06: -1 Not configured |
| Zone07: -1 Not configured | Zone08: -1 Not configured |
| Zone09: -1 Not configured | Zone10: -1 Not configured |
| Zone11: -1 Not configured | Zone12: -1 Not configured |
| Zone13: -1 Not configured | Zone14: -1 Not configured |
| Zone15: -1 Not configured | Zone16: -1 Not configured |
| Zone17: -1 Not configured | Zone18: -1 Not configured |
| Zone19: -1 Not configured | Zone20: -1 Not configured |

Enter requested entry

Press enter for next part, 99 to leave>

Path: 2 Configuration → 1 Outputs → 6/7 MOBALine / impulse line 1/2 → Configure time zone table (world time)

Display of all time zone entries (20) of the world time function for MOBALine.

By entering a zone number, the particular entry can be changed.

Select time zone (see chapter "6.5.28 Time zone selection")

Exit the page with 99. The changes are first saved on the overlying menu page or reset.

6.5.7 Impulse line

Impulse clock line. Display of line 1 or 2.

```

DTS 4132.timeserver Moser-Baer AG
=====

IMPULSE CLOCK LINE                               1
1 Line type                                       Imp.
2 Line                                             on
3 Line mode                                       1min
4 Time zone                                       [+1] Brussel
5 Max. current                                    500mA
6 Line time                                       07:39:39 17.01.2016
7 Pulse time                                       300ms
8 Pause time                                       300ms
9 Catch up mode (0=12h, 1=24h, 2=week)          0
98 Return and save
99 Return and discard changes

Enter desired menu number>
    
```

Path: 2 Configuration → 1 Outputs → 6/7 MOBALine / impulse line 1/2

1. Select line type: 0 = MOBALine, 1 = Impulse line, 2 = DCF active code line
2. Select line function: Line switched off, line switched on
3. Select line mode: Minute steps, ½ minute steps, 1/5 minute steps, 1/8 minute steps, second steps
4. Select time zone (see chapter “6.5.28 Time zone selection“)
5. Select maximum current (0-1,000mA) on the line. The line will be switched off as long as the overcurrent is connected.
The maximum current is divided between both lines, i.e. it can always only be the remainder at the most that can be set as maximum current.
6. Line time with the format: “hh:mm:ss DD.MM.YYYY“
7. Pulse time (200-30000ms, resolution approx. 50ms)
8. Pause time in catch-up (200-30000ms, resolution approx. 50ms)
9. Catch-up mode: 12 hrs, 24 hrs, 1 week



Important: Changes can only be undertaken when the clock line is switched off!

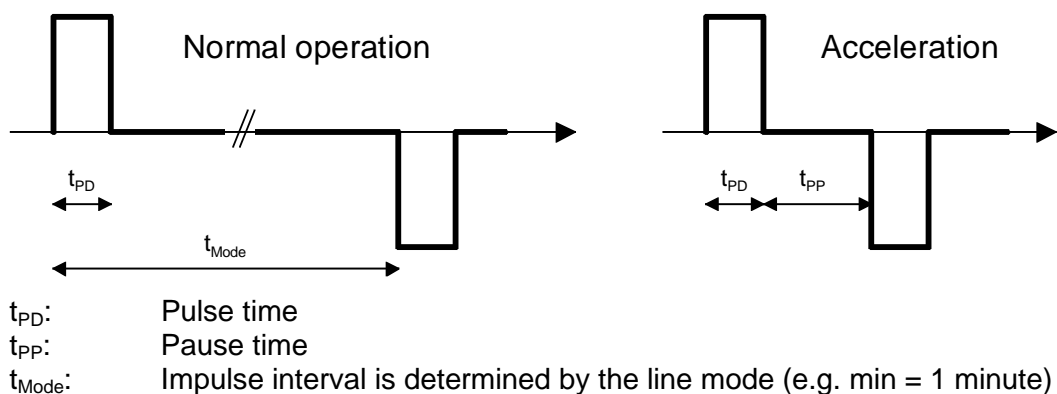

6.5.8 DCF active code line

DCF active code line. Display of line 1 or 2.

```
DTS 4132.timeserver Moser-Baer AG
=====

DCF ACTIVE CLOCK LINE                1
1 Line type                          DCF
2 Line                                on
3 Line mode                           2
4 Time zone                           [+1] Brussel
5 Max. current                         500mA

98 Return and save
99 Return and discard changes

Enter desired menu number>
```

Path: 2 Configuration → 1 Outputs → 6/7 MOBALine / impulse line 1/2

1. Select line type: 0 = MOBALine, 1 = Impulse line, 2 = DCF active code line
2. Select line function: Line switched off, line switched on
3. Select line mode: See the diagrams on the next page.
4. Select time zone (see chapter “6.5.28 Time zone selection“)
5. Select maximum current (0-1000mA) on the line. The line will be switched off as long as the overcurrent is connected and restarted only on the next minute. The maximum current is divided between both lines, i.e. it can always only be the remainder at the most, that can be set as maximum current.



Important: Changes can only be undertaken when the clock line is switched off!

The six different DCF active code modes:

Mode 1

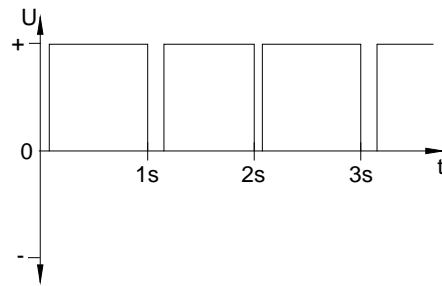

Mode 2

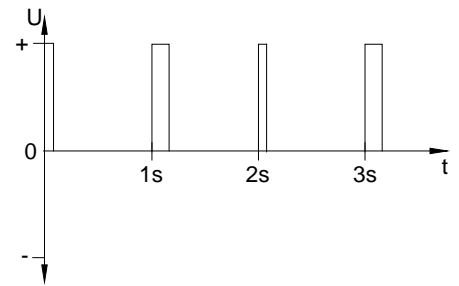

Mode 3

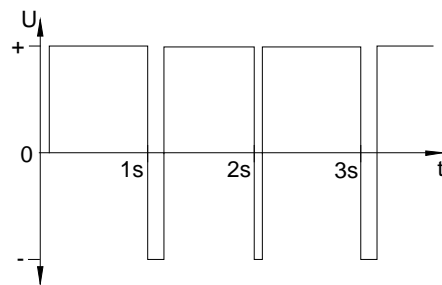

Mode 4

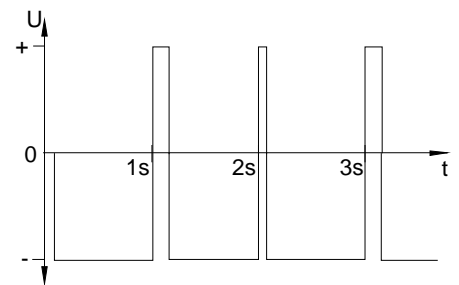

Mode 5:

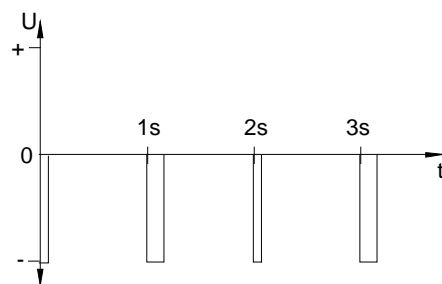

Mode 6

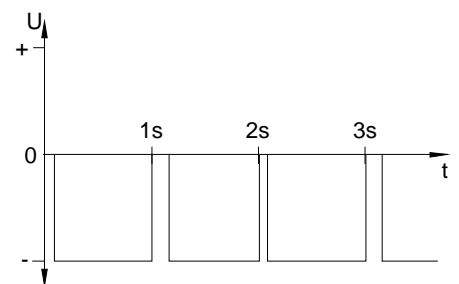

Mode 1/6, 2/5, 3/4 are equal. Their polarity only depends on how the line is connected to the DTS 4132.timeserver. The signal forms shows the voltage measured from terminal a to terminal b (refer to annex A).

6.5.9 Switch function / Switch program

Switch functions for MOBALine (channel relay) to switch illumination.

```
DTS 4132.timeserver Moser-Baer AG
=====

SWITCH FUNCTIONS
1 Time zone [ +1] Brussel
2 Program file test.prg
3 Switch function twilight
4 Actual channel conditions / manual control

98 Return and save
99 Return and discard changes

Enter desired menu number>
```

Path: 2 Configuration → 1 Outputs → 8 Switching functions

1. Time zone selection (see chapter “6.5.28 Time zone selection“)
2. Selection of the program file changes to the menu “SELECTION OF FILE“
3. Switch function twilight changes to the menu “SWITCH FUNCTION TWILIGHT“
4. Actual channel conditions / manual control changes to the menu “CHANNEL STATE“

In chapter “10 Description of the switch function“ the construction and dependence of the switch function is described.

Selection of the switch program file:

```
DTS 4132.timeserver Moser-Baer AG
=====

SELECTION OF FILE Page 1
00: haustec1.prg 01: haustec9.prg
02: test.prg 03: testprg1.prg

Enter requested file number, 99 = no file

Press enter for next part, ESC to leave>
```

Copying the program files is described in chapter "7.10 Copying Telegram or Program files to the DTS 4132.timeserver".

Enter **99** to remove the file selection.

Switching function twilight:

The switch function calculates sunrise and sunset on the basis of the position entered. The accuracy of the calculation is +/-5 min. within the limits 60° north 60° south.

The switch function can be linked with AND, OR, or exclusive to a channel.

```
DTS 4132.timeserver Moser-Baer AG
=====

SWITCHING FUNCTION TWILIGHT
1 Channel (1-64, 0=off)                off
2 Combination twilight function        0
3 Longitude in degrees, -=East        -7.466°
4 Latitude in degrees, -=South        46.916°
5 On before sunrise                    0min
6 Off after sunrise                    0min
7 On before sunset                     0min
8 Off after sunset                     0min
   Actual state                        off
98 Return and save
99 Return and discard changes

Enter desired menu number>
```

Path: 2 Configuration → 1 Outputs → 8 Switching functions → 3 Switching function twilight

1. Channel: 0 = off, 1 - 64 = assigned channel.
 2. Link Twilight:
 - 0 = Exclusive twilight function (the switch programs are hidden on this channel)
 - 1 = The twilight function is linked to the switch program OR
 - 2 = The twilight function is linked to the switch program AND
 3. Position: longitude in degrees. East = negative. Example: -7.466° = E 7.466°
 4. Position: latitude in degrees. South = negative. Example: 47.030° = N 47.030°
 5. Switch on 0 – 600 min before sunrise (defines how many minutes before the calculated sunrise time it has to be switched on).
 6. Switch off 0 – 600 min after sunrise (defines how many minutes after the calculated sunrise time it has to be switched off).
 7. Switch on 0 – 600 min before sunset (defines how many minutes before the calculated sunset time it has to be switched on).
 8. Switch off 0 – 600 min after sunset (defines how many minutes after the calculated sunset time it has to be switched off).
 - 1: With this value, the switch off time is delayed till the next sunrise → the illumination is switched on the whole night.
- Actual state: shows if the switch function is on or off. The state change of the lines (MOBALine) can be delayed up to 1 min.

Channel state:

```
DTS 4132.timeserver Moser-Baer AG
=====

CHANNEL STATE      * = channel on, [ ] = channel locked
                   ! = external input, s = twilight
01: * 02: 03: 04: 05: 06: 07: 08:
09:[*] 10:s 11: * 12: 13: 14: 15: 16:
17: 18: 19:[ ] 20: 21: 22: 23: 24:
25: 26: 27: 28: 29: 30: 31: 32:
33: 34: 35: 36: 37: 38: 39: 40:
41: 42: 43: 44: 45: 46: 47: 48:
49: 50: 51: 52: 53: 54: 55: 56:
57: 58: 59: 60: 61: 62: 63: 64:

99 Return

Manual switching: Enter channel number

Enter desired menu number>
```

Path: 2 Configuration → 1 Outputs → 8 Switching functions → 4 Actual channel conditions / manual control

Display of all 64 channels of the switch functions.

A switched on channel is displayed with an *.

[] shows a locked channel in a switched off state whereas [*] shows a switched on channel in a locked state.

! : not used. DTS 4132 is not equipped with external inputs.

An s shows that the channel is linked to the twilight calculation.

By entering a channel, the page can be changed to that of manual switching for that channel.

Important: After a restart or after changing the program file, it can take up to 2 min until the states displayed correspond to the effective states on the channel relay!



Manual switching:

```
DTS 4132.timeserver Moser-Baer AG
=====

MANUAL SWITCHING                               Channel: 1
1 Channel on
2 Channel off
3 Channel on and lock
4 Channel off and lock
5 Channel unlock

99 Return

Enter desired menu number>
```

Path: 2 Configuration → 1 Outputs → 8 Switching functions → 4 Actual channel conditions / manual control → 01

1. Channel on: The channel is switched on immediately. The channel then takes over the state of the switch programs, switch function or switch inputs again. It can take up to 2 minutes to adopt.
2. Channel off: The channel is switched off immediately. The channel then takes over the state of the switch programs, switch function or switch inputs again. It can take up to 2 minutes to adopt.
3. Channel on and lock: The channel is switched on immediately and locked in this state.
4. Channel off and lock: The channel is switched off immediately and locked in this state.
5. Unlock channel: The channel takes over the state of the switch programs, switch function or switch inputs again. It can take up to 2 minutes to adopt.

6.5.10 Time handling

Under time handling, settings can be made for the following functions:

- Time source configuration → see chapter "6.5.6 Time source"
- Time adjustment configuration → see chapter "6.5.12 Time adjustment / Time-keeping"
- Redundant operation → see chapter "6.5.13 Redundant operation"
- NTP Server → see chapter "6.5.14 NTP server"
- For setting the time manually → see chapter "6.5.15 Manual time set / Leap second"

6.5.11 Time source

Time source configuration.

```
DTS 4132.timeserver Moser-Baer AG
=====

TIME SOURCE
1 Source type                2
2 Time zone of the source    [0] UTC
3 Alarm delay for failure of the source 60min
4 DTS stratum (0=auto, 1-15=fix) 0
5 Stratum limit for synchalarm 12
6 Stratum TO (1-16) DCF/GPS fail 24h
7 Offset per stratum        50ms
8 Max. offset for time ok    50000us
9 Time source correction (DCF/GPS only) 0ns
98 Return and save
99 Return and discard changes

Enter desired menu number>
```

Path: 2 Configuration → 2 Time handling → 1 Time source setting

1. Type of time source: 0=none, 1=DCF low quality (DCF 77 receiver, MET), 2=DCF high quality (GPS receiver, UTC), 3=NTP
2. Time zone of the source: see chapter 6.5.28 Time zone selection.
3. Alarm delay at failure of time source (minutes):
0 = off, 1-2'160min, default = 0
Error: "loss of time source TO" resp. "loss of local source" in redundant mode as slave
4. DTS stratum: 0=Stratum is automatically calculated according to the time source (see chapter 8.3).
1-15= Stratum is set on a fix value
5. Stratum limits for alarm: Limits for alarm "Time source stratum lost" (1-16)
6. Stratum TO (Timeout):
Duration of stratum change 1 to 16 in the case of time loss (1-999h), e.g. 24 hrs → stratum counts up from 1 to 16 within 24 hrs.
Default value: 12h
7. Offset per Stratum in ms (0 – 40'000 ms). Stratum is calculated with this value when time is received again:
Offset/Stratum = 30 ms, offset of the time source 150 ms → Stratum = 5
8. Max. offset for time source to set valid time in μs at start up.
(0-1'000'000μs)
9. Time source correction (only for DCF), +/-60'000ms

For description of time source see chapter "8 Time administration"

6.5.12 Time adjustment / Time-keeping

```
DTS 4132.timeserver Moser-Baer AG
=====

TIME ADJUSTMENT CONFIGURATION
1 Adjust mode (0=follow, 1=set)          1
2 Max. catch up speed                   100000ns/s
3 Time core type (0-255, default 0)     1
4 Synch. only offset                     0ms
5 RTC mode                               0

98 Return and save
99 Return and discard changes

Enter desired menu number>
```

Path: 2 Configuration → 2 Time handling → 2 Time adjustment setting

1. Adjust mode: 0=time is slowly adjusted (without time steps)
1=time is set immediately
2. Maximum catch up speed in ns/s (0-10'000'000).
3. Quartz type: Standard=0 (0-255)
4. Synch. only offset: 0=off
100-5000ms=Limits as from which time is no longer accepted → Alarm "Syn only diff too great"
5. RTC mode 0=RTC deactivated
1=ON, with initial time set, independent of the mode (1)
2=ON



Notice: Explanation to the RTC mode:

RTC mode 0:

After startup of the device the system time starts at 00:00. First of all, the device has to receive the time from its time source. The time adjust happens according to the "1 Adjust mode".

RTC mode 1:

The internal real time clock (RTC) is activated. After startup of the device the system time is set with the RTC time.

The first takeover of the time from the time source happens in one step, independent from the Adjust mode (1) setting.

RTC mode 2:

The internal real time clock (RTC) is activated. After startup of the device the system time is set with the RTC time.

The time takeover from the time source happens according to the Adjust mode (1).

- Adjust mode = 0: time is slowly adjusted
- Adjust mode = 1: time is set immediately



Important! For the redundant operation, the RTC mode should be switched off!

For a description of time-keeping see chapter "8 Time administration"

6.5.13 Redundant operation

```
DTS 4132.timeserver Moser-Baer AG
=====

REDUNDANT OPERATION
1 Mode (0=single, 1=red., 2=red. LAN1-LAN2) 0
2 Stratum limit (1-16) 16
3 Max. offset to slave source 100000us
4 Port for LAN link 14338
5 IP address 2. DTS 4132
6 Set master manual

98 Return and save
99 Return and discard changes

Enter desired menu number>
```

Path: 2 Configuration → 2 Time handling → 3 Redundant operation

1. Mode: 0=single operation
1=redundant operation of 2 DTS 4132 (Master-Slave operation)
2=redundant operation of 2 DTS 4132 (Master-Slave operation) without LAN communication between the 2 devices.
2. Stratum limit to switch from slave to master. Standard 16 (1-16)
3. Max. offset of slaves to the slave time source for triggering the alarm "Offset Source (Slave)" (0-5'000'000us)
4. Port for LAN-Link. default 14338
5. IP address of the 2nd DTS 4132. Only required if the optical link is not working. Format 10.241.23.99
ENTER without entering an address will delete the entry.
6. Manual change from slave to master. The command is effected immediately. Saving with '98' is not required when exiting the menu.

For a description of redundant operation, see chapter "8.10 Redundant operation of 2 DTS 4132.timeservers"



Important! For the redundant operation, the RTC mode should be switched off!

Important! LAN link in redundant mode:

For the redundant operation with additional LAN link, only the LAN 1 can be used. If this is not possible, select redundant Mode 2.
The LAN link is only used for internal communication between the two servers. It is not a redundancy for the optical link.

6.5.14 NTP server

NTP can run as server or combined as server/client. To run NTP as source (NTP as client), in the menu '2. Configuration' → '2. Time handling' → '1. Time source setting' → '1. Source type' choose NTP and set at least one server. If NTP server is configured, but NTP is not indicated as time source, NTP only runs as backup time source (redundancy) to the actual time source.

The exact behavior of NTP time sources is described in chapter "8.4 Time acceptance from NTP".

Further two multicast or broadcast addresses can be configured.

```
DTS 4132.timeserver Moser-Baer AG
=====

NTP SERVER CONFIGURATION
1 Configuration timeserver address 1
2 Configuration timeserver address 2
3 Configuration timeserver address 3
4 Configuration timeserver address 4
5 Configuration multi-/broadcast address 1
6 Configuration multi-/broadcast address 2
7 NTP Authentication / Access
  NTP slave clock line (info only)

99 Return

Enter desired menu number>
```

Path: 2 Configuration → 2 Time handling → 4 NTP server

- 1.-4. Summary about configured NTP – time sources. Select to configure.
- 5.-6. Summary about configured NTP – broadcast addresses. Select to configure.
7. NTP Authentication: Changes to the menu "NTP AUTHENTICATION"
Information about a multicast – address, configured for NTP slave clocks.

Configuration of the individual server/peer address is as follows:

```
DTS 4132.timeserver Moser-Baer AG
=====

ENTRY TIMESOURCE                1
1 Source                          0
2 Minpoll                         0
3 Maxpoll                         0
4 Server/Peer                     server
5 Prefer                          off
6 Authentication key              off

98 Return and save
99 Return and discard changes

Enter desired menu number>
```

Path: 2 Configuration → 2 Time handling → 4 NTP server → 1/2/3/4 Configuration timeserver address 1/2/3/4

1. Insert time sources (IP address or name, e.g. "ntp.metas.ch")
ENTER without entry of an address will delete value.
- 2.-3. Configurations of **Minpoll** and **Maxpoll**: Inquiry interval $2^{\text{poll value}}$ in seconds.
0 = automatically
e.g. poll value=2 → intervall 2: $2^2 = 4\text{sec.}$, poll value=5 → intervall 5: $2^5 = 32\text{sec.}$
Range of poll values (exponent): 1 – 16
To get an exact synchronization it's better to limit Maxpoll to 6 (64 sec.).
4. Set type of NTP inquiry: server or peer
5. Preferred source: on or off
6. Authentication key: off, key number, autokey



Notice: If a key number is entered, the entered key must also be added to the trusted keys.



Notice: All changes lead to a restart of the NTP server!



Notice: If NTP only runs as a backup (source DCF or GPS), no NTP source should be indicated as **prefer!**



Notice: Maxpoll should not be selected under 4 (16 sec), as otherwise, internal trimming (adjustment) may be inaccurate.
Maxpoll and Minpoll on automatic can lead to insufficient synchronization accuracy. The specified accuracies were measured with Minpoll = 3 and Maxpoll = 6.
The configuration server should be used whenever possible.

Configuration of the Multi- / Broadcast address is as follows:

```
DTS 4132.timeserver Moser-Baer AG
=====

NTP MULTI- / BROADCAST-ENTRY          1
1 Multi- or broadcast IP address
2 Interval                             4sec
3 TTL (only for multicast)             1hops
4 Authentication key                   off

98 Return and save
99 Return and discard changes

Enter desired menu number>
```

Path: 2 Configuration → 2 Time handling → 4 NTP server → 5/6 Configuration multi-/broadcast address 1/2

1. IP address of the destination network (multicast or broadcast).
ENTER without entering an address will delete the entry.
2. Interval for sending out the NTP information in seconds.
The interval is rounded after the entry to NTP standard, which only permits values of format 2^x : 1,2,4,8,16,32,64... Maximum 65536 seconds.
3. TTL (time to live) in hops. Only required for multicast.
Number of routers over which the multicast packet should be transmitted: for simple networks without a router - enter 1, for 1 router - enter value 2.
4. Authentication key: off, key number, autokey



Notice: All changes lead to a restart of the NTP server.

Configuration of the NTP authentication:

The NTP authentication is described in chapter "8.9 NTP Authentication".

```
DTS 4132.timeserver Moser-Baer AG
=====

NTP AUTHENTICATION
1 Import keys (from /ram)
2 Export keys (to /ram)
3 Trusted (active) keys
4 Request keys (ntpq) off
5 Control keys (ntpd) off
6 Autokey password
7 Autokey command
8 Access control for query off

98 Return and save
99 Return and discard changes

Enter desired menu number>
```

Path: 2 Configuration → 2 Time handling → 4 NTP server → NTP Authentication / Access NTP slave clock line (info only)

1. Import keys (from /ram directory)
The file ntp.keys must first be copied into the directory /ram.

Notice: The file must be named exactly in this way and written entirely in small letters.

2. Export keys (to /ram directory)
The current ntp.keys file is written in the directory /ram.
3. Select the trusted keys separated by space
4. Select the request key
5. Select the control key
6. Set the auto key password
7. Execute for auto key commands:
gen_iff generate the IFF certificate
gen_gq generate the GQ certificate
gen_mv* generate the MV certificate
gen_all* generate all (IFF,GQ,MV) certificates
gen_client generate the client certificate
update_server update the server certificate
update_client update the client certificate
export_iff export the IFF server certificate to /ram. Parameter password of the client

export_gq export the GQ server certificate to /ram.
export_mv* export the MV server certificate to /ram.
import_iff import the IFF server certificate from /ram.
import_gq import the GQ server certificate from /ram.
import_mv* import the MV server certificate from /ram.
clear_ram delete the certificates in /ram
clear_keys delete the certificates in the NTP key directory
Example: *export_iff myPassword* exports the IFF client certificate to /ram.
*MV schema is currently not available
8. Access control for query: 0= full access (off)
1 = access from local network allowed (local)
2 = no access (on)



6.5.15 Manual time set / Leap second

```
DTS 4132.timeserver Moser-Baer AG
=====

MANUAL TIME SET
1 Set time (UTC)
2 Adjust time
3 Leap second mode 0
4 Leap second date (UTC) 00:00:00 01.07.15

98 Return and save
99 Return and discard changes

Enter desired menu number>
```

Path: 2 Configuration → 2 Time handling → 5 Manual time adjustment / leap second

1. Set UTC time in the format "hh:mm:ss DD.MM.YY".
Time is set with ENTER!
2. Correct time in ms (- = backwards). Range: +/-10'000ms
Time is set with ENTER!
3. Leap second mode:
 - 0 off
 - 1 Additional second will be inserted at entered time
Is set to 0=off after inserting the leap second.
 - 1 Second will be left out at entered time
Is set to 0=off after inserting the leap second.
 - 2 Recognize leap second automatically. Only possible with a source with leap second announcement!
4. Set UTC time of leap second in format: "hh:mm:ss DD.MM.YY"

For a description of the leap second, see chapter "8.8 Leap second"

6.5.16 Alarms

Under alarms, settings can be undertaken for the following functions:

- Alarm relay → see chapter 6.5.17
- E-mail → see chapter 6.5.19
- SNMP traps → see chapter 6.5.20
- Alarm input → see chapter 6.5.21

6.5.17 Alarm relay

```
DTS 4132.timeserver Moser-Baer AG
=====

ALARM CONFIGURATION 2
1 Alarmmask for relay

98 Return and save
99 Return and discard changes

Enter desired menu number>
```

Path: 2 Configuration → 3 Alarms → 1 Alarm relay

1. Alarm mask for relay (see chapter "6.5.18 Alarm mask")

6.5.18 Alarm mask

```
DTS 4132.timeserver Moser-Baer AG
=====

ALARMMASK                                     Page 1
[ ]=error disabled, [*]=error enabled
[*] Bit00: DTS restart                        [*] Bit01: Error bit1
[*] Bit02: Supply voltage too low            [*] Bit03: Failure supply 1
[*] Bit04: Failure supply 2                  [*] Bit05: Error voltage 5V
[*] Bit06: Error voltage 2.5V                [*] Bit07: Error voltage 1.25V
[*] Bit08: Wrong time zone DCF               [*] Bit09: Error Time Zone TC
[*] Bit10: Error bit10                       [*] Bit11: Alarm input
[*] Bit12: Line 1 current high                [*] Bit13: Error time zone line 1
[*] Bit14: Line 2 current high                [*] Bit15: Error time zone line 2

Enter alarmnumber to alter mask

Press ENTER for next part, 99 to leave>
```

Path: 2 Configuration → 3 Alarms → 1 Alarm relay → Alarm mask for relay

Display of all the DTS 4132 alarms (64) on 4 pages. Pages can be scrolled through with ENTER.

An alarm on the current page can be switched on or off by entering an error number. The page can be exited with 99. The modifications will be saved or restored one menu level higher in "ALARM CONFIGURATION". All Alarms with "error bitxx" are not yet used.

A description of individual errors can be found in appendix "C Alarm list".

The alarm masks for the various applications (E-mail, SNMP, SNMP Traps, alarm relay) can differ.

6.5.19 E-mail

```
DTS 4132.timeserver Moser-Baer AG
=====
```

```
MAIL CONFIGURATION                               Page 1
1 Mailmode                                       off
2 Alarmmask for mail                             ff ff ff ff ff ff ff ff
3 Mailserver
4 Mailport (default 25)                           25
5 Destination mail address1
6 Destination mail address2
7 Reply mail address
8 From mail address

98 Return and save
99 Return and discard changes

Enter desired menu number>
```

Path: 2 Configuration → 3 Alarms → 2 E-Mail

1. E-mail function on or off.
2. Alarm mask for e-mail notifications (see chapter "6.5.18 Alarm mask")
Changes are stored or reset on the overlying menu page "MAIL CONFIGURATION".
3. IP address of the mail server e.g. 10.249.34.5
ENTER without entering an address will delete the entry.
4. Mail server port (often 25)
- 5.-6. Destination e-mail address.
ENTER without entering an address will delete the entry.
7. Reply address (e.g. support, administrator...)
ENTER without entering an address will delete the entry.
8. Sender address (important for authentication through the mail server)
ENTER without entering an address will delete the entry.

Press ENTER to change to page 2.

Notice: Configuration of a gateway is required for sending e-mails (see chapter "6.5.23 Network"). This can be set via DHCP or manually.



E-mail configuration page 2:

```
DTS 4132.timeserver Moser-Baer AG
=====
```

```
MAIL CONFIGURATION                               Page 2
11 Authentication mode                            0
12 User name
13 Password

98 Return and save
99 Return and discard changes

Enter desired menu number>
```

Path: 2 Configuration → 3 Alarms → 2 E-Mail → ENTER

11. Authentication mode:
 - 0=off (sender e-mail address used for authentication)
 - 1=auto (tries CRAM-MD5, LOGIN- PLAIN in this sequence)
 - 2=PLAIN
 - 3=LOGIN
 - 4=CRAM-MD5
12. User name (only for authentication mode 1-4)
13. Password (only for authentication mode 1-4)

Press ENTER to change to page 1.

Format of an error message via E-mail:

```
Event <Alarm 03 set: Power failure 1>
Time <11:26:45 10.01.07>
Hostname <DTS4132 (10.241.0.30)>
```

6.5.20 SNMP traps

For a description of SNMP functionality, see also chapter "9 SNMP". Traps are also designated as notifications (from SNMP V2)

```
DTS 4132.timeserver Moser-Baer AG
=====

SNMP-TRAP CONFIGURATION
1 Trap mode off
2 Alarmmask for trap ff ff ff ff ff ff ff ff
3 Trap community string trapmobatime
4 Configuration of destination 1
5 Configuration of destination 2
6 Time periode for alive message 0

98 Return and save
99 Return and discard changes

Enter desired menu number>
```

Path: 2 Configuration → 3 Alarms → 3 Traps

1. Trap mode on or off (applies to alarm and alive traps)
2. Alarm mask for SNMP trap messages (see chapter "6.5.18 Alarm mask")
Changes are first stored or reset on the overlying menu page "SNMP TRAP CONFIGURATION".
3. Trap community string (group membership for traps).
Standard: *trapmobatime*.
4. Configuration of the receiving system (trap sink) 1
5. Configuration of the receiving system (trap sink) 2
6. Time period for alive messages in seconds. 0 = no alive traps are sent
Range: 1-7'200sec

 **Notice:** General settings for SNMP can be found in menu '2. Configuration' → '7. SNMP'. See also chapter "6.5.25 SNMP").

 **Notice:** Configuration of a gateway is required for sending SNMP traps (see chapter 6.5.23 Network). This can be set via DHCP or manually.

 **Notice:** Each configuration change leads to a restart of the DTS SNMP Agent.

Configuration of the receiving systems

```
DTS 4132.timeserver Moser-Baer AG
=====

SNMP-TRAP DESTINATION CONFIGURATION          1
1 Address trap destination
2 Port trap destination (default 162)       162
3 SNMP version                               2

98 Return and save
99 Return and discard changes

Enter desired menu number>
```

Path: 2 Configuration → 3 Alarms → 3 Traps → 4/5 Configuration of destination 1/2

1. Address of the evaluation system e.g. 10.240.0.9.
ENTER without entering an address will delete the entry.
2. Port of the evaluation system (usually 162).
3. SNMP Version: 1=SNMP V1, 2=SNMP V2c



Notice: Each configuration change leads to a restart of the DTS SNMP Agent.

6.5.21 Alarm input

Description of the functionality of the alarm input.

```
DTS 4132.timeserver Moser-Baer AG
=====

ALARM INPUT CONFIGURATION
1 Mode                                     off

98 Return and save
99 Return and discard changes

Enter desired menu number>
```

Path: 2 Configuration → 3 Alarms → 4 Alarm input

1. Mode off, on or inverted.

6.5.22 General settings

```
DTS 4132.timeserver Moser-Baer AG
=====

GENERAL SETTINGS
1 Language                               0
2 Timezone displayed times               [+1] Brussel
3 Power (0=single, 1=red.)              0
4 Password (menu)                        DTS

98 Return and save
99 Return and discard changes

Enter desired menu number>
```

Path: 2 Configuration → 4 General

1. Setting the display language
2. Setting the time zone for the display, and also all alarm logs, e-mail and SNMP.
(See chapter 6.5.28 Time zone selection).
3. Power: 0=simple power, 1=redundant power
(See chapter “11 Power supply alternatives“)
4. Enter password for the menu (user **dts**) (max. 15 characters).
A password must be configured.

6.5.23 Network

```
DTS 4132.timeserver  Moser-Baer AG
=====

NETWORK GENERAL
1  IPV4 Configuration LAN 1
2  IPV6 Configuration LAN 1
3  Network Interface LAN 1          auto
4  IPV4 Configuration LAN 2
5  IPV6 Configuration LAN 2
6  Network Interface LAN 2          auto
7  Host name (Device name)         DTS4132
8  Domain name

98 Return and save
99 Return and discard changes

Enter desired menu number>
```

Path: 2 Configuration → 5 Network

1. Configuration of IPv4 parameters LAN 1
2. Configuration of IPv6 parameters LAN 1
3. Set network interface LAN 1: Auto, 100/10Mbit, half, full duplex.
4. Configuration of IPv4 parameters LAN 2
5. Configuration of IPv6 parameters LAN 2
6. Set network interface LAN 2: Auto, 100/10Mbit, half, full duplex.
7. Set host name.

Notice: A host name must always be configured.

Host names and their format are described in the Internet standards RFC 952 and RFC 1123:

Domains and host names may only contain letters (capitals or small letters) and numerals ("0-9"). In addition, the hyphen ("-") may also be used, as long as it is not at the end.

Everything else is not permitted!

8. Set domain e.g. test.org

View of the current network state in Menu: '1 Status' → '6 Info network config.'

Notice: The menu is closed upon modifying the IP or the DHCP mode.

Notice: DHCP on/off, each change of this setting will result in a **restart** of the NTP server!

Notice: For the operation of a **Multicast** communication (NTP and Time Zone Server) **the configuration of a gateway is mandatory**. The gateway can be set manually or by using DHCP. If no gateway is available, the own IP address can be used.

Notice: Only one DNS server should be configured (IPv4 or IPv6).





Notice: Modifications to the network must be coordinated with the network administrator!

Notice: The LAN 1 gateway has priority compared to the LAN 2 gateway! An external NTP server must be reachable either in LAN 1, LAN 2 or via gateway of LAN 1.

Notice: If only one LAN interface is used, it always has to be LAN 1!

Notice: The two LAN interfaces may not be configured in the same network (subnet)!

Network configuration IPv4:

```

DTS 4132.timeserver  Moser-Baer AG
=====

NETWORK IPV4                                LAN 1
1  DHCP                                       on
2  IP address                               DHCP
3  Subnet mask                              DHCP
4  Gateway                                  DHCP
5  DNS server                               DHCP

98 Return and save
99 Return and discard changes

Enter desired menu number>

```

Path: 2 Configuration → 5 Network → 1/4 IPV4 Configuration LAN 1/2

1. DHCP on or off, the following fields are not available in case of DHCP = on. A DHCP **renew** can also be triggered via this point.



Notice: DHCP on, if no DHCP server is available, leads to longer start-up time (<75 sec.) of the DTS.

- 2.-5. Set IP address, subnet mask, gateway and DNS server. Format = 10.240.98.7

Network configuration IPv6:

```
DTS 4132.timeserver Moser-Baer AG
=====

NETWORK IPV6                                LAN 1
1 Mode / Autoconf                            off
2 DHCPv6                                      off
3 IP address 1 / Prefix                       0::0/64
4 Gateway 1                                   0::0
5 DNS server                                  0::0

98 Return and save
99 Return and discard changes

Enter desired menu number>
```

Path: 2 Configuration → 5 Network → 2/5 IPV6 Configuration LAN 1/2

1. Autoconf on or off
2. DHCPv6 on or off
3. IP address with prefix in IPv6 format
e.g. 2001:2345:6789::12:1:34/64
4. Gateway in IPv6 format
5. IPv6 DNS server

6.5.24 Services (network services FTP, telnet, SSH...)

Network services configuration:

```
DTS 4132.timeserver Moser-Baer AG
=====

NETWORK SERVICES
1 telnet                                     on
2 ftp                                        on
3 ssh, scp, sftp                             on

98 Return and save
99 Return and discard changes

Enter desired menu number>
```

Path: 2 Configuration → 6 Services (FTP, telnet, SSH)

- 1.-3. Switch the individual services off or on.

6.5.25 SNMP

For a description of SNMP functionality, see also chapter "9 SNMP".

```
DTS 4132.timeserver Moser-Baer AG
=====

SNMP CONFIGURATION
1  SNMP mode                               on
2  Alarmmask for SNMP                       ff ff ff ff ff ff ff ff
3  DTS location
4  Contact information
5  SNMP V1/V2c security configuration
6  SNMP V3 security configuration

98 Return and save
99 Return and discard changes

Enter desired menu number>
```

Path: 2 Configuration → 7 SNMP

1. Mode. 0=off, 1= V1 + V2c + V3, 2=V2c + V3, 3=V3 only
The MIB 2 SNMP information is also available with "Mode = off".

 **Notice:** To send out MIB-2 traps, the trap community and the destination address must at least be configured in menu '2. Configuration' → '3. Alarms' → '3. Traps'. See also chapter "6.5.20 SNMP traps".

2. Alarm mask for SNMP status (see chapter "6.5.18 Alarm mask"). The modifications will be saved or restored one menu level higher in "SNMP CONFIGURATION".
3. DTS Location information, which is displayed in SNMP management tool.
4. Contact information, which is displayed in SNMP management tool.
5. Configuration of SNMP V1 / V2 c (specific settings). See chapter "6.5.26 SNMP V1 / V2c"
6. Configuration of SNMP V3 (specific settings). See chapter "6.5.27 SNMP V3"

 **Notice:** Each configuration change leads to a restart of the DTS SNMP Agent.

6.5.26 SNMP V1 / V2c

```
DTS 4132.timeserver Moser-Baer AG
=====

SNMP V1/V2c CONFIGURATION
1 Readonly community string          romobotime
2 Read/write community string       rwmobotime

98 Return and save
99 Return and discard changes

Enter desired menu number>
```

Path: 2 Configuration → 7 SNMP → 5 SNMP V1/V2c security configuration

1. Community string for **read only** (Group membership for GET).
Standard: *romobotime*.
2. Community string for **read/write** (Group membership for GET/PUT).
Standard: *rwmobotime*.



Notice: Each configuration change leads to a restart of the DTS SNMP Agent.

6.5.27 SNMP V3

```
DTS 4132.timeserver Moser-Baer AG
=====

SNMP V3 CONFIGURATION
1 User 1 configuration (DTSUser1)
2 User 2 configuration (DTSUser2)
3 Access 1 configuration (viewDTS1)
4 Access 2 configuration (viewDTS2)

99 Return

Enter desired menu number>
```

Path: 2 Configuration → 7 SNMP → 6 SNMP V3 security configuration

1. – 2. Configuration of user-defined SNMP accounts DTSUser1 and DTSUser2
3. – 4. Configuration of user-defined SNMP access rights viewDTS1 and viewDTS2

Notice: Each configuration change leads to a restart of the DTS SNMP Agent.

User configuration SNMP V3:

```
DTS 4132.timeserver Moser-Baer AG
=====

SNMP V3 USER CONFIGURATION
1 Password for authent. and privacy          DTSUser1
2 Min security level                         mobatime
3 Read access (read view)                   auth
4 Write access (write view)                 _all_
                                           viewDTS1

98 Return and save
99 Return and discard changes

Enter desired menu number>
```

Path: 2 Configuration → 7 SNMP → 6 SNMP V3 security configuration → 1/2 User 1/2 configuration (DTSUser1/2)

1. Password for authentication (MD5) and privacy (DES). 8 – 40 characters.
2. Minimal security level: 1=noauth (no authentication)
2=auth (only authentication)
3=priv (authentication and privacy)
3. SNMP read access: 0=none (no access)
1=all (full access)
2=DTS info (only DTS specific information)
3=user defined 1 (viewDTS1)
4=user defined 2 (viewDTS2)
4. SNMP write access 0=none (no access)
1=all (full access)
2=DTS info (only DTS specific information)
3=user defined 1 (viewDTS1)
4=user defined 2 (viewDTS2)

Notice: Each configuration change leads to a restart of the DTS SNMP Agent.



Access configuration SNMP V3:

```
DTS 4132.timeserver Moser-Baer AG
=====
```

```
SNMP V3 ACCESS CONFIGURATION          viewDTS1
1 Include OID 1                        .1.3.6.1.4.1.8072
2 Include OID 2                        .1.3.6.1.4.1.2021
3 Include OID 3                        .1.3.6.1.4.1.13842.4
4 Exclude OID 1                        .2
5 Exclude OID 2                        .2
6 Exclude OID 3                        .2
```

```
98 Return and save
99 Return and discard changes
```

```
Enter desired menu number>
```

Path: 2 Configuration → 7 SNMP → 6 SNMP V3 security configuration → 3/4 Access 1/2 configuration (viewDTS1/2)

1. - 3. Include View path, form: `.1.3.6.1.4.1.13842.4` (e.g. DTS) or `.iso` (complete SNMP ISO path).
4. - 6. Exclude View path: analogue include.



Notice: Each configuration change leads to a restart of the DTS SNMP Agent.

6.5.28 Time zone selection

```
DTS 4132.timeserver Moser-Baer AG
=====

SELECTION TIME ZONE                                     Page 1
 00: [0] UTC                                           01: [0] London
* 02: [+1] Brussel                                     03: [+2] Athens
 04: [+2] Bucharest                                    05: [+2] Cairo
 06: [+2] Amman                                        07: [0] UTC
 08: [+3] Kuwait                                       09: [-1] Cape Verde
 10: [0] UTC                                           11: [+4] Abu Dhabi
 12: [+4.5] Kabul                                       13: [-8] Pitcairn Is.
 14: [+5] Tashkent                                     15: [+5.5] Mumbai
 16: [+6] Astana                                       17: [+7] Bangkok
 18: [+8] Singapore                                    19: [+9] Tokyo

Enter requested time zone

Press enter for next part, ESC to leave>
```

Display of all the DTS 4132 time zones (100) over several pages. The pages can be scrolled through with ENTER.

A time zone can be selected on the current page by entering a time zone number.

Only one time zone can be selected.

A * indicates the selected time zone.

Press ESC to leave the page. The modifications will be saved or restored one menu level higher.

6.6 Maintenance menu

```
DTS 4132.timeserver  Moser-Baer AG
=====

MAINTENANCE
1  Update software (FTP)
2  Update software (USB)
3  Backup configuration and log to USB
4  Backup configuration local
5  Restore configuration (backup)
6  Restore configuration (default MOBA)
7  Restart device
8  Copy telegram files

99 Return

Enter desired menu number>
```

Path: 3 Maintenance

1. Initiating a software update (files must have been copied by FTP into the directory */ram* of the DTS 4132 before). → See chapter "7 Updates".
The command always leads to a restart of the DTS 4132 (even if no files were copied for update).



Notice: Possibly save configuration first.

2. Initiate a software update (files must first be put on to a USB stick in the DTS 4132). → See chapter "7 Updates". The command always leads to a restart of the DTS 4132 (even if no files were copied for update)



Notice: Possibly save configuration first.

3. Save the entire configuration (incl. telegram files) and the log files on a USB stick . Also generates a diagnosis file (DTS4132system_XXXXXXXXXX.log) in the directory */ram* which is also copied on to the USB stick or which can be downloaded per FTP (only for support).
4. Backup the entire configuration locally (→ file DTS4132.conf.bkp is created).
5. Restore the entire configuration from a backup stored locally.
6. Restore the entire configuration to factory settings.
7. Restart DTS 4132.
8. Copy telegram files onto the DTS 4132.
→ See chapter "7.10 Copying Telegram or Program files to the DTS 4132.timeserver".

See also chapter "7 Updates".

7 Updates

7.1 Updating images with MOBA-NMS

Steps for updating images using MOBA-NMS:

1. Select DTS device(s) in the device view.
2. Menu 'Edit' → 'Commands' → Select 'Firmware Update...'
3. Enter the path to the file 'dtscheck.md5' or select it using the 'Browse...' button.
4. Enter further paths to images or select them using the 'Browse...' button.
5. Optionally: Check the box 'Backup device(s) configuration before update' and enter the destination directory for the backup file(s). If a destination folder is selected, the whole device configuration will be saved before the backup. Additionally, if the image 'dts4132cfg.img' is written too, the saved configuration can be automatically restored after the update. For this, check the box 'restore configuration after update'.
6. By clicking the 'OK' button, the update is initiated.



Important: The update procedure (item 6) can take some time (<5 min.) and may not be interrupted under any circumstances. In case of an interruption, the software on the DTS 4132 is destroyed and can only be repaired in the factory.

7.2 Updating images with FTP

Possible images are: u-bootDTS4132, rootfsDTS4132.img, ulmageDTS4132, dts4132app.img, dts4132cfg.img. Additionally the file dtscheck.md5 must exist.

→ **all file names are case-sensitive.**

Steps for updating images:

1. Connect a FTP client software to the DTS 4132 e.g. with Internet Explorer enter: **ftp://dts@[IP address]** (as user DTS).
See also chapter
2. If an update of the image **dtscfg.img** is made, the configuration of the DTS 4132 and the telegram files are overwritten. In order to store the configuration, the file *dts4132.conf* from the directory **/etc** and any possible telegram files must be saved from the directory **/var/local/dts**. After the update, the file can again be written on the DTS 4132 in accordance with chapter "7.3 Updating applications or configurations with FTP".
3. Change to the directory **/ram**.
4. Copy the image into the directory **/ram**.
5. Close FTP connection.
6. The update procedure can be started on DTS 4132 by selecting the menu '3. Maintenance' → '1. Update software (FTP)' and press ENTER. The message "Update in progress" appears and at the same time, "Please wait!>" is shown in the command line. All images are copied. The DTS 4132 is automatically restarted on completion of the update.
The Telnet or SSH session has to be restarted.



Notice: The update procedure (point 6) may take some time depending on the type and number of images (<5 min) and must not be interrupted under any circumstances. If interrupted, the software on the DTS 4132 will be destroyed and the DTS 4132 has to be returned to the manufacturer for repairing.

Starting up after an update can also take some minutes (<10 min), or it can result in an additional restart, as the file systems have to be checked first.

To eliminate any mistakes during update procedure, the versions should be verified after the update.

7.3 Updating applications or configurations with FTP

To update individual files such as, e.g. dts4132app, dts4132menu, ntpd, dts4132mod.ko, dts4132.conf, etc. on the DTS 4132, the following steps are carried out
➔ **all file names are case-sensitive:**

1. Connect a FTP client software to the DTS 4132 e.g. with Internet Explorer enter: **ftp://dts@[IP address]** (as user DTS). See also chapter 7.6 FTP connection
2. Change to the directory */ram*.
3. Copy all the files to be updated into the directory */ram*.
4. Close FTP connection.
5. The update procedure can be started on DTS 4132 by selecting the menu '3. Maintenance' ➔ '1. Update software (FTP)' and press ENTER.
The message "Update in progress" appears and at the same time, "Please wait!>" is shown in the command line. All images are copied. The DTS 4132 is automatically restarted on completion of the update.
The Telnet or SSH session has to be restarted.



Notice: The update procedure (point 5) may take longer time depending on the type and number of images (<5 min) and must not be interrupted under any circumstances. If interrupted, the software on the DTS 4132 will be destroyed and the DTS 4132 has to be returned to the manufacturer for repairing.

To eliminate any mistakes during update procedure, the versions should be verified after the update.

7.4 Updating images via USB

Possible images are: u-bootDTS4132, rootfsDTS4132.img, ulmageDTS4132, dts4132app.img, dts4132cfg.img. Additionally the file dtscheck.md5 must exist.
➔ **all file names are case-sensitive.**

Steps for updating images:

1. Copy images to the USB stick
2. Plug the stick in the DTS 4132
3. If an update of the **dtscfg.img** image is made, the configuration of the DTS 4132 and the telegram files are overwritten. In order to store the configuration, the file *DTS4132.conf* from the directory ***/etc*** and any possible telegram files must be saved from the directory ***/var/local/dts***. After the update, the file can again be written on the DTS 4132 in accordance with chapter "7.3 Updating applications or configurations with FTP".

4. The update procedure can be started on DTS 4132 by selecting the menu '3. Maintenance' → '2. Update software (USB)' and press ENTER. The message "Update in progress" appears and at the same time, "Please wait!>" is shown in the command line. All images are copied. The DTS 4132 is automatically restarted on completion of the update. The Telnet or SSH session has to be restarted.
5. As soon as the DTS 4132 is restarted, remove the USB stick.



Notice: The update procedure (point 4) may take longer time depending on the type and number of images (<5 min) and must not be interrupted under any circumstances. If interrupted, the software on the DTS 4132 will be destroyed and has to be returned to the manufacturer for repairing.

Starting up after an update can also take some minutes (<10 min), or it can result in an additional restart, as the file systems have to be checked first .

To eliminate any mistakes during update procedure, the versions should be verified after the update.

7.5 Updating applications or configurations via USB

To update individual files, e.g. dts4132app, dts4132menu, ntpd, dts4132mod.ko, dts4132.conf, etc. on the DTS 4132, the following steps are carried out

→ **all file names are case-sensitive, all names with 4132:**

1. Copy applications (or configuration) to the USB stick
2. Plug the stick in the DTS 4132
3. The update procedure can be started on DTS 4132 by selecting the menu '3. Maintenance' → '2. Update software (USB)' and press ENTER. The message "Update in progress" appears and at the same time, "Please wait!>" is shown in the command line. All applications are copied. The DTS 4132 is automatically restarted on completion of the update. The Telnet or SSH session has to be restarted.
4. As soon as the DTS 4132 is restarted, remove the USB stick.



Notice: The update procedure (point 3) may take longer time depending on the type and number of images (<5 min) and must not be interrupted under any circumstances. If interrupted, the software on the DTS 4132 will be destroyed and the DTS 4132 has to be returned to the manufacturer for repair.

To eliminate any mistakes during the update procedure, the versions should be verified after the update.



Important: USB stick recognition: After removing the USB stick, wait approx. 1 min. before re-inserting the it again. Otherwise it can be, that the USB stick is not recognized.

7.6 FTP connection

Establish anonymous connection:

ftp://“IP address of DTS 4132”

to directly reach the sub-directory */ram*, e.g. Explorer *ftp://10.241.0.5*

Establish connection as/with a user:

ftp://dts@“IP address of DTS 4132”.

e.g. with Internet Explorer enter: *ftp://DTS@10.241.0.5*

Password: **dts** resp. the defined password for the menu.

To directly reach the sub-directory */ram*, you can also enter
ftp://dts@10.241.0.5/ram.

Establish connection with IPv6:

The address **must** be written in brackets []:

e.g. with Internet Explorer enter: *ftp://dts@[fd03:4432:4646:3454::2000]*



Notice: The file has to be copied in binary mode (not ASCII).

FTP tools

| | Windows XP, 7, 8, 10 | Linux (Suse, Redhat) |
|--|---|----------------------|
| Integrated in the system (file manager): | Windows Explorer Start → Execute: Explorer | Konqueror / Dolphin |
| Programs (examples) | CuteFTP | Kbear |

7.7 SFTP connection

SFTP = SSH File Transfer Protocol

SFTP tools

| | Windows XP, 7, 8, 10 | Linux (Suse, Redhat) |
|--|----------------------|----------------------|
| Integrated in the system (file manager): | - | Konqueror / Dolphin |
| Programs (examples) | WinSCP | - |

7.8 SCP connection

SCP = Secure Copy Protocol

Notice: SCP connection can only be established when no menu (operation) is open.

The following error message can be ignored. There is no influence in the functionality of the operation:

```
Command 'groups'  
failed with termination code 127 and error message  
-sh: groups: not found.
```

SCP tools

| | Windows XP, 7, 8, 10 | Linux (Suse, Redhat) |
|--|----------------------|----------------------|
| Integrated in the system (file manager): | - | With command line |
| Programs (examples) | WinSCP | - |

7.9 Save Configuration externally

(for backup or copy to another DTS 4132)

Save the current configuration via MOBA-NMS:

1. Select DTS device in the device view.
2. Menu 'Edit' → Select 'Backup configuration...'.
3. Select the elements that are to be saved. (In case of doubt, select everything)
4. Click button 'Next >'.
5. Indicate destination file by clicking the 'Browse...' button.
6. Optionally: enter a free backup comment. E.g. reason for the backup, use, etc. This comment will then be shown during the restoration of the backup.
7. By clicking the 'Finish' button, the backup is created.
8. At the end of the backup, an overview of the process is shown. It shows which elements were saved and which ones are not available or could not be saved.

Save the current configuration via FTP:

1. Connect a FTP client software to the DTS 4132 (with Internet Explorer enter: **ftp://dts@"IP address"**) (as user DTS).
2. Change to the DTS 4132 directory **/etc**.
3. Save the file **dts4132.conf** (configuration) to the user PC (e.g. copy the file to the Desktop or to the directory *My Documents*).
4. Additionally also save possible telegram files from the directory **/var/local/dts**.

Save the current configuration via USB-Stick:

The whole procedure can be analogously done with an USB stick.

The copy procedure to the USB stick can be started on DTS 4132 by selecting the menu '3. Maintenance' → '3. Backup configuration and log to USB' and press ENTER. All files (including telegram files) will be copied into the root directory of the USB stick.

Copy configuration to another DTS 4132:

In order to copy the entire configuration or elements of it from a DTS device to another, the according assistant in MOBA-NMS can be used. For this, select the source device (from which the configuration shall be transferred) and start the assistant in the menu 'Edit' → 'Transfer configuration...'. It will lead you through the individual steps.

Without MOBA-NMS, perform the procedure explained in chapter 7.3 resp. 7.5.

Notice: When copying the configuration from one DTS 4132 to an other, the IP address may have to be changed after the download by serial connection.



7.10 Copying Telegram or Program files to the DTS 4132.timeserver

Analogously to the previously described procedures telegram and program files can be copied via FTP or USB stick to the DTS 4132.

The copy procedure can be started on DTS 4132 by selecting the menu '3. Maintenance' → '8. Copy telegram-files' and press ENTER. Afterwards, select again in the menu "6.5.4 Serial interface" and reload.

The files are stored in the directory **/var/local/DTS** and can be deleted or copied via FTP.

Special case USB stick:

If the DTS recognizes the insertion of an USB stick, it is shown on the display. By pressing the red button the copy procedure can be released (analogously to the above described procedure). The button has to be pressed until the copy procedure is started.

Management with MOBA-NMS:

With MOBA-NMS, the files do not need to be copied manually via FTP or USB stick, since this is already integrated in the MOBA-NMS operation. At every file selection, the 'Change...' link can be clicked. This opens a file dialog which shows all files and allows new files to be loaded onto the device or existing ones to be deleted.

Example of a program file choice:

Program file: [Change...](#)

Link for opening the file dialog for editing the file list.



Notice: After the file copy procedure, the output of the telegram files are re-started (take over of the files).



Notice: The **file name** is limited to **8 characters** before the dot, e.g. **IF482Std.tel**

8 Time administration

8.1 Concept of time administration

The internal master clock as well as the real-time clock runs with UTC (Universal Time Coordinated). The synchronization inputs, the time shown on the display, as well as all outputs are linked via a time zone entry with the master clock time, i.e. all inputs and outputs can be individually allocated to a specific time zone.

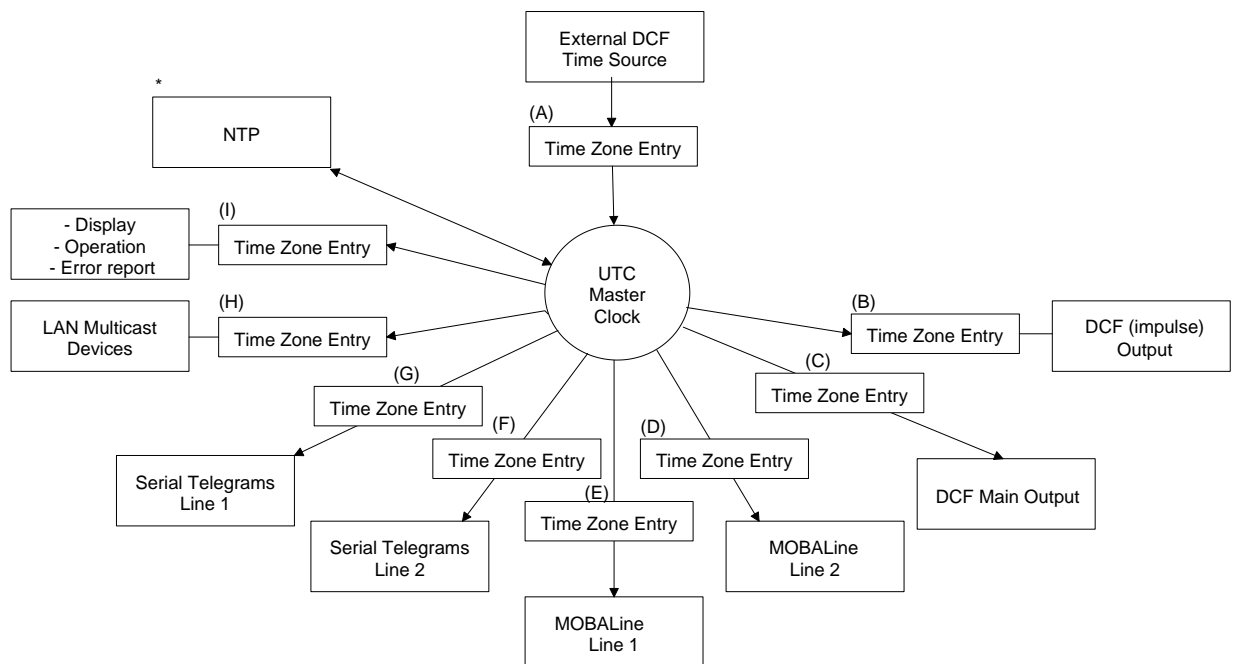

Configurable time zones:

- (A) chapter 6.5.11 Time source
- (B) chapter 6.5.3 DCF / Pulse / Frequency output
- (C) chapter 6.5.2 DCF – output
- (D) chapter 6.5.6 MOBALine
- (E) chapter 6.5.6 MOBALine
- (F) chapter 6.5.4 Serial interface
- (G) chapter 6.5.4 Serial interface
- (H) chapter 6.5.5 NTP slave clocks / time zone server
- (I) chapter 6.5.22 General settings
- * NTP is always UTC

8.2 Time acceptance

Variants of time synchronization

- Adjusting:
After starting the DTS 4132, the time is set for a first time (from source or manually). Afterwards, the time will only be aligned with maximum adjusting speed if deviating from the source → **no time steps possible**.
Configuration: see chapter “6.5.12 Time adjustment / Time-keeping“
- Setting:
Time deviations are always corrected in full immediately: Seconds are set immediately; partial seconds are corrected with 50ms/s.

Manual time set:

- The time is always set immediately. The stratum is set to 1 or pre-set to a fix stratum. If new source time information is available, the time will be adjusted again and the stratum set accordingly.

8.3 Time acceptance from an external source (DCF or GPS)

Acceptance from an external source (DCF input):

- At least 2 minutes reception (DCF-GPS) is required, before the NTP server is available.
Time source stratum = 0 → stratum of the DTS 4132 = 1

Stratum normal, synchronized operation:

- The stratum value behaves as follows for synchronization from the time source:
If $St_fix > 0$: then stratum = St_fix (particularly for manually set time) applies
If $St_fix = 0$: then stratum = 1

Stratum in case of error:

- The stratum value behaves as follows in the case of external time source loss:
If $St_fix > 0$: then stratum = St_fix applies
If $St_fix = 0$:
then stratum = $\text{MIN}((t_current - t_lastsynch)/(To * 255), St_max)$ applies
- Adjusting the clock after identifying a leap in time:
If $St_fix > 0$: then stratum = St_fix applies
If $Tst > 0$ AND $St_fix = 0$: then stratum = $\text{MIN}(Tdiff/Tst, St_max)$ applies
If $Tst = 0$ AND $St_fix = 0$: then stratum = 1 (auto) applies

Legend:

| | |
|------------------|--|
| To: | Stratum TO <0-16>, Stratum error timeout time 1-999 [h], for loss of the external source |
| St_fix: | 0..15, configurable stratum, 0 = auto |
| St_max: | 1..16, configurable stratum, 0 = auto |
| t_current [s]: | current time |
| t_lastsynch [s]: | time of the last synchronization |
| Tst: | Offset per stratum, 0..40'000 [ms], parameter time deviation for stratum alteration by 1 |
| Tdiff: | current time difference in ms |

8.4 Time acceptance from NTP

Acceptance:

- As NTP RFC 1305, RFC 5905 (www.ntp.org)
(see <http://ntp.isc.org/bin/view/Servers/WebHome> for internet-server)

Stratum in normal, synchronized operation:

- Stratum value of DTS is always one step higher than that of the current NTP time server

Stratum in case of an error

- As NTP RFC 1305, RFC 5905 (www.ntp.org)

8.5 NTP as backup

If DTS 4132 is synchronized with a DCF or GPS source, the NTP can be used as redundancy source. This function is active, as soon as at least one time server is configured in menu '2. Configuration' → '2. Time handling' → '4. NTP server'.

Stratum in normal, synchronized operation:

- Equal Stratum value "Time Acceptance from an external source (DCF or GPS)"

Behavior in case of an error:

- Failure of primary Source:
"St. est": Means: Expected NTP Stratum of the NTP sources
"St. est" = MAX(Stratum NTP candidates)
→ Means: "St. est" contains the stratum value of the poorest NTP source.
If internal Stratum > "St. est" + 1, then change to NTP as source takes place
(internal stratum is one step higher than that of the poorest available NTP source).
- As soon as the primary source is available again, the changes are set back.

8.6 Time server

- NTP v4 (compatible with v3) as per RFC 1305, RFC 5905 (Port 123)
- SNTP (UDP), RFC 2030 (Port 123)
- TIME (TCP/UDP), RFC 868 (Port 37)
- DAYTIME (TCP/UDP), RFC 867 (Port 13)

8.7 Time accuracy, time-keeping

See appendix H Technical data.

8.8 Leap second

The announcement of the switching second is put out by DCF and NTP* each time 1 hour before the defined time.

*The announcement is only sent via NTP if a DCF source is active. If only one NTP source is configured, the state of this source is passed on.

Automatic mode

In the automatic mode, the source (DCF or NTP) is checked for a possible announcement during 1 hour prior to the moment of a possible leap second. If the announcement is recognized, it is passed through the NTP and DCF outputs and the leap second is inserted.

The leap second can be inserted at 2 moments per year: 00:00:00 1.1. or 00:00:00 1.7. each in UTC. Whether a leap second is inserted is decided by the organization IERS (<http://www.iers.org>) each time up to half a year in advance.

8.9 NTP Authentication

NTP provides two variants for authentication in version 4:

- NTP symmetric keys (i.e. symmetric keys)
- NTP autokeys

NTP authentication assures a correct time source and prevents manipulation of NTP information. NTP data itself is, however, not encoded.

8.9.1 NTP symmetric keys

A 32-bit key ID and a cryptographic 64/128-bit check sum of the packet is attached to each NTP IP packet.

The following algorithms are used for this purpose:

- Data Encryption Standard (DES)
(partly restricted in North America and no longer integrated into new NTP variants (>V4.2))
- Message Digest (MD5)

The DTS 4132 only supports the MD5 procedure.

The receiving NTP service calculates the check sum with an algorithm and compares it with the one contained in the packet. Both NTP services must have the same encryption key and the same corresponding key ID for this purpose.

Packets with a wrong key or wrong check sum will not be used for synchronization .

The DTS 4132 must be correspondingly configured to be able to use NTP authentication (chapter 6.5.14 NTP server). The NTP service of the other equipment (e.g. server, PC...) must also be configured. In the case of standard NTP, this occurs via the ntp.conf file:

```
# path for key file
keys /etc/ntp/ntp.keys
trustedkey 1 2 3 4 5 6# define trusted keys
requestkey 4 # key (7) for accessing server variables
controlkey 5 # key (6) for accessing server variables

server ntp1.test.org key 2
server ntp2.test.org key 6
server 192.168.23.5 key 3
```

The description of the ntp.conf file can be accessed via the corresponding man-page, or consulted at <http://www.eecis.udel.edu/~mills/ntp/html/authopt.html>

The authentication mode is automatically activated when a key is used and the paths for the keys have been correspondingly configured.

`trustedkey` defines all keys currently permitted

`requestkey` defines the key for the ntpq help tool.

`controlkey` defines the key for the ntpdc help tool.

The keys are located in the ntp.keys file defined with `keys`. This has the following format:

```
1    M    TestTest
2    M    df2ab658
15   M    I_see!
498  M    NTPv4.98
```

The key ID is in the first column of the file, the format of the keys in the second defined column, and the key itself in the third. There are four key formats, however, nowadays only the MD5 is still used → M. The letter M is no longer written for new NTP variants (>V4.2) and is only necessary for backwards compatibility.

The signs ' ', '#', '\t', '\n' and '\0' are not used in the MD5 ASCII key! Key 0 is reserved for special purposes and should therefore not be used here.

ntp.keys: man page for ntp.keys to be noted (check the internet)

8.9.2 NTP Autokey

The validity of the time received to the NTP clients is assured by symmetric keys. For a higher degree of certainty, exchanging the keys used regularly is, however, necessary to obtain protection, e.g. from replay attacks (i.e. attacks in which recorded network traffic is simply played back).

The autokey procedure was introduced as the exchange is very involved in a large network. A combination of group keys and public keys enables all NTP clients to check the validity of the time information which they receive from servers in their own autokey group.

NTP Autokey is relatively complex in its use and studying the functionality is definitely necessary beforehand.

Autokey is described at <http://www.cis.udel.edu/~mills/proto.html> or on the NTP homepage <http://www.ntp.org>.

Autokey is currently defined in an IETF draft.

<http://www.ietf.org/internet-drafts/draft-ietf-ntp-autokey-04.txt>

The configuration of Autokey is explained in

<http://support.ntp.org/bin/view/Support/ConfiguringAutokey> or in

<http://www.ntp.org/ntpfaq/NTP-s-config-adv.htm#S-CONFIG-ADV-AUTH>.

8.10 Redundant operation of 2 DTS 4132.timeservers

For redundant operation two DTS 4132 devices are synchronized via optical fibers. For this purpose, a mini GBIC module is plugged into both devices and connected via optical fibers (see Appendix H Technical data):



mini GBIC module

Both devices have a GPS receiver in redundant operation or external timeservers as time source. Both devices are configured for the redundant mode, but are basically equal and work out the master/slave role among themselves. The slave is always synchronized to the master in operation. The slave supervises the system time on the basis of its own GPS time (or external timeserver time) and generates an error message, should the time difference amount exceed the configurable value of n milliseconds.

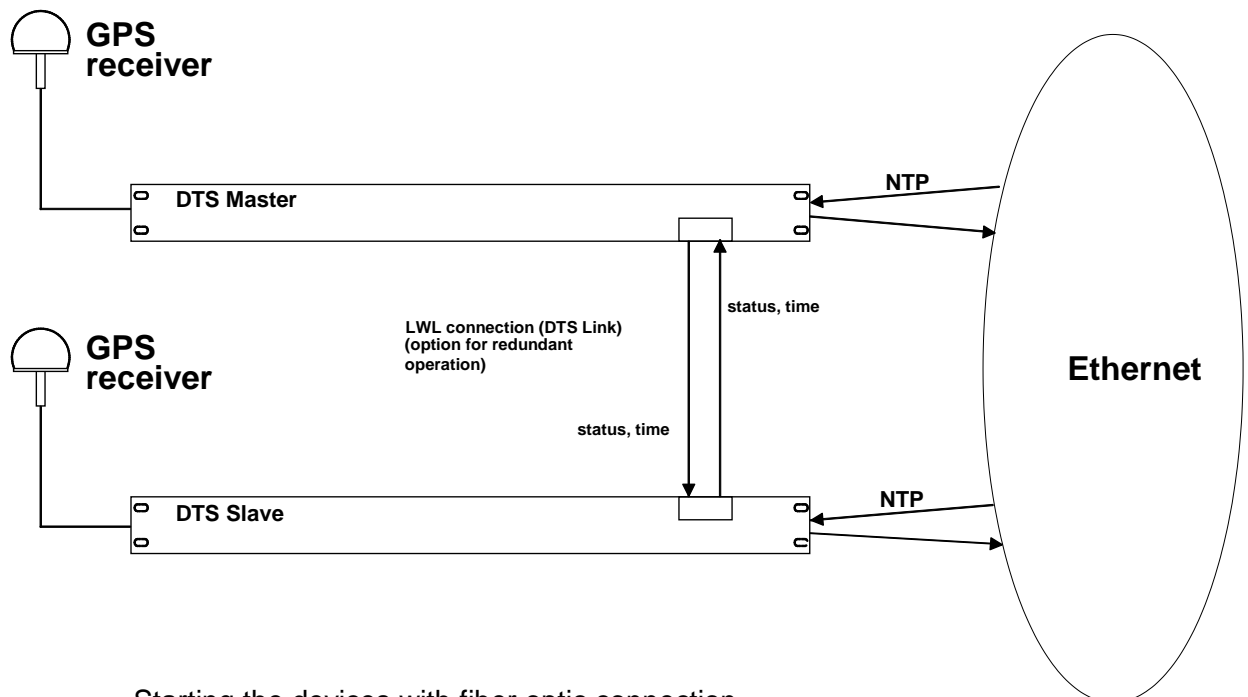

- Starting the devices with fiber optic connection
The devices work out among themselves which is the master (normally the one synchronized first)
- Starting the devices without fiber optic connection
The devices do not send out any time information until there is an optical fiber connection, or the devices are reconfigured.
- The slave synchronizes to the master.
Whereby $\text{stratum/slave} = \text{stratum/master} + 1$
The time of the slave is always set immediately to the master time (no fine adjustment).

- In case of loss of the master's time source, the master stratum increases on the basis of the configurable parameters up to the maximum stratum. The slave follows, i.e. the slave stratum is always 1 higher. The slave takes over the master role from a configurable stratum value (if the status of the slave is better than that of the master) and synchronizes to its own time source. The previous master becomes the slave. This distribution of roles remains until the new master loses the synchronization.
- In the case of a loss of the master, the slave takes over the master function.
- If the former master is working again, it takes over the actual time of the current master and remains in slave mode.
- In the case of a fiber optic connection loss, the slave checks the status of the master over the network and remains in slave mode as long as the master is accessible and is working normally. If the master is no longer accessible or has a worse status, the slave takes over the master function.

NTP

The NTP clients select the server with the lower stratum.

Redundant Mode 2: No LAN communication between the two DTS

The two redundant DTS 4132 are not located in the same network. Therefore they have no possibility to communicate through LAN.

The role decision (master, slave) takes place exclusively via opt. link.

RTC:

RTC is to be deactivated for the redundant mode.

Redunant operation with external NTP server:

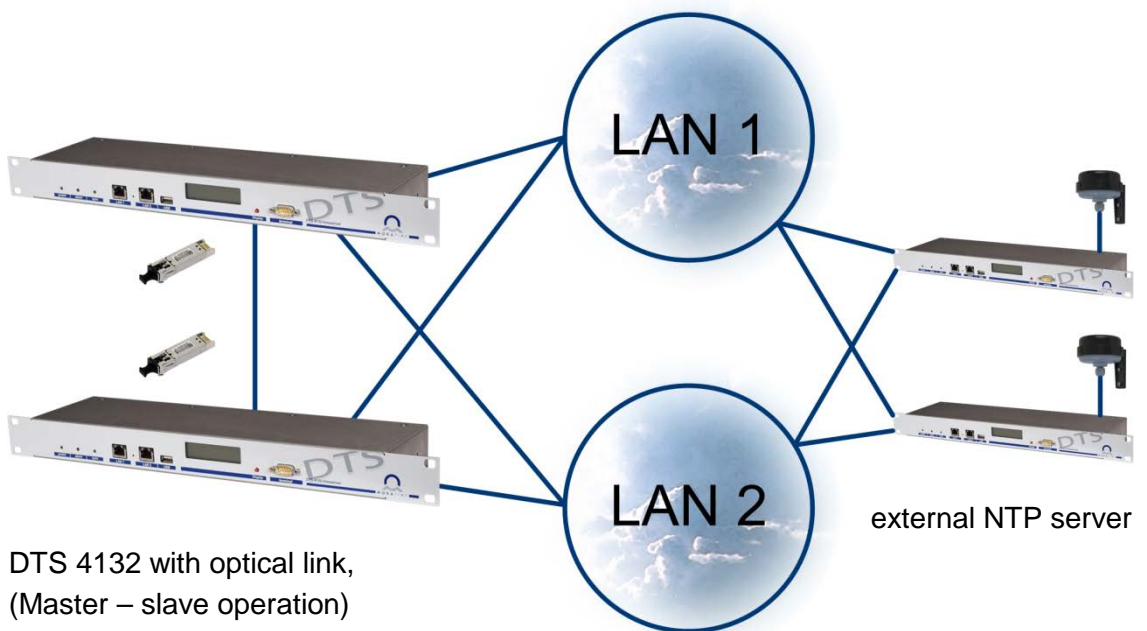

DTS 4132 with optical link,
(Master – slave operation)
synchr. from one or more external
NTP server

9.1 General

The SNMP version **V2c** or **V3** for *Get*, *Put* and *Notification* (Trap) is used.

A full SNMP agent is implemented on the DTS (MIB II, DTS4132).

For SNMP V2c, following standard *Communities* are used:

| | |
|-------------|---------------------|
| Read only : | <i>romobotime</i> |
| Read/Write: | <i>rwmobotime</i> |
| Trap: | <i>trapmobotime</i> |

For SNMP V3, following standard *User / Passwords* are used:

| | | |
|-----------------|-----------------|------------------------------------|
| <i>dtsUser1</i> | <i>mobotime</i> | |
| <i>dtsUser2</i> | <i>mobotime</i> | |
| <i>dtsInfo</i> | <i>mobotime</i> | <i>(not changeable, read only)</i> |

dtsUser1 and *dtsUser2* have full read/write access on all objects. With SNMP V3 rules, access can be reduced. Changes of the rules can only be modified over the DTS menu but not via SNMP.

SNMP V3 agent supports user validation (authentication MD5) and encoding (encryption DES).

MIB II values like *sysDescr*, *sysContact*, *sysName*, or *sysLocation* can only be modified over the DTS menu but not via SNMP.

The following MIB definitions are used:

SNMPv2-SMI, SNMPv2-MIB, SNMPv2-CONF, SNMPv2-TC, SNMPv2-TM, SNMP-FRAMEWORK-MIB, SNMP-MPD-MIB, SNMP-NOTIFICATION-MIB, SNMP-TARGET-MIB, SNMP-USER-BASED-SM-MIB, SNMP-VIEW-BASED-ACM-MIB, RFC1213-MIB, IF-MIB, IP-MIB, IP-FORWARD-MIB, TCP-MIB, UDP-MIB, HOST-RESOURCES-MIB, HOST-RESOURCES-TYPES, DISMAN-EVENT-MIB, NOTIFICATION-LOG-MIB, UCD-SNMP-MIB, NET-SNMP-MIB, NET-SNMP-TC

SNMP V2c, V3:

| | |
|---|----------------------------|
| DTS-COMMON | (File: DTS-COMMON-MIB.TXT) |
| General DTS definition, always required | |
| DTS4132 | (DTS4132-MIB.TXT) |
| Device-specific DTS definitions | |

The MIB files can be copied from the DTS 4132 with FTP (For FTP use, see chapter "7.6 FTP connection"):

| | |
|----------------|------------------------------|
| DTS-MIB: | <i>/etc/snmp/mibs/</i> |
| Standard MIBS: | <i>/usr/share/snmp/mibs/</i> |

9.2 Device configuration with SNMP

If one or several variables are set with *Put* in a configuration group, the variable *dts4132????ConfigCmd* must be set at the end to 1 in the corresponding group. The values of the entire configuration group are assumed from the DTS with this command (1=Save).

As long as the accept command has not been set, the changed variables can be restored to the old values by setting the *dts4132????ConfigCmd* variable to 2 (2=undo, restore).

After sending the accept command, a *dts4132ConfigChanged Notification* is sent.

The definitions of the available variables can be taken from the MIB files.

Example:

| Management-System | | DTS |
|--|---|--|
| <i>Put</i> dts4132FTPMode=1 | → | Variable is set to 1 internally |
| <i>Put</i> dts4132NetServicesConfigCmd=1 | → | Configuration group is assumed |
| | ← | Sends <i>dts4132ConfigChanged Notification</i> with the new time <i>dts4132NetConfigChangedTime</i> |

9.3 DTS subagent SNMP notification

Protocol: SNMPv2c Notification

For *Notifications* to be sent out, SNMP must be switched on. In addition, at least one receiver system must be configured.

9.3.1 Startup

[dts4132StartUp]

Sent out when the subagent for the DTS is started.

This *Notification* is always sent out, as soon as SNMP is activated and a destination address is configured.

9.3.2 Shutdown

[dts4132Shutdown]

Sent out when the subagent for the DTS is stopped.

This *Notification* is always sent out, as soon as SNMP is activated and a destination address is configured.

9.3.3 Status changed

[dts4132StatusChanged]

Sent out when the subagent detects a status change in the DTS application process. The following variables are monitored for changes:

dts4132SysStatus, dts4132NTPTInfoCurrentSource, dts4132SysStratum

This *Notification* is always sent out, as soon as SNMP is activated, and a destination address is configured.

The *Notification* sent out contains the following data:

| Field | Type | Size | Description | Example |
|----------------------|--------------|---------|---------------------------------------|------------------|
| dts4132SysStatus | Unsigned Int | 4 Bytes | Contains the internal system status | 66309 |
| dts4132SysOffset | Integer | 4 Bytes | Actual time offset of the system [us] | -1523 → -1.523ms |
| dts4132SysTimeSource | Byte | 1 Byte | Actual time source | 2 |
| dts4132SysStratum | Byte | 1 Byte | Actual system stratum level | 1 |

9.3.4 Configuration changed

[dts4132ConfigChanged]

Sent out when the subagent detects a configuration change in the DTS application processes.

This *Notification* is always sent out, as soon as SNMP is activated and a destination address is configured.

The *Notification* sent out contains the following data:

| Field | Type | Size | Group |
|---|-----------|---------|----------------------------|
| dts4132SysConfigChangedTime | TimeTicks | 4 Bytes | dts4132System |
| dts4132NetworkIf0ConfigChangedTime | TimeTicks | 4 Bytes | dts4132NetworkIf0 |
| dts4132NetworkIf1ConfigChangedTime | TimeTicks | 4 Bytes | dts4132NetworkIf1 |
| dts4132NetConfigChangedTime | TimeTicks | 4 Bytes | dts4132Network |
| dts4132NetServicesConfigChangedTime | TimeTicks | 4 Bytes | dts4132NetServices |
| dts4132TSConfigChangedTime | TimeTicks | 4 Bytes | dts4132TimeSource |
| dts4132RedOpConfigChangedTime | TimeTicks | 4 Bytes | dts4132TimeRedundantOp |
| dts4132NTPConfigChangedTime | TimeTicks | 4 Bytes | dts4132TimeNTPServer |
| dts4132OutMainDCFConfigChangedTime | TimeTicks | 4 Bytes | dts4132OutMainDCF |
| dts4132OutLineDCFPulseFREQConfigChangedTime | TimeTicks | 4 Bytes | dts4132OutLineDCFPulseFREQ |
| dts4132OutLineSerialConfigChangedTime | TimeTicks | 4 Bytes | dts4132OutLineSerial |
| dts4132OutLineTZServerConfigChangedTime | TimeTicks | 4 Bytes | dts4132OutLineTZServer |
| dts4132RelayConfigChangedTime | TimeTicks | 4 Bytes | dts4132AlarmRelayConfig |
| dts4132MailConfigChangedTime | TimeTicks | 4 Bytes | dts4132AlarmMailConfig |
| dts4132SnmpConfigChangedTime | TimeTicks | 4 Bytes | dts4132SnmpConfig |
| dts4132SnmpV3ConfigChangedTime | TimeTicks | 4 Bytes | dts4132SnmpV3 |

The *ConfigChangedTime* variables show the time of the last change of the relevant configuration group as TimeTicks value in 1/100th seconds. The management system can decide on the basis of these time values, which configurations need to be reloaded.

The groups and their parameters are listed in appendix "G Parameters".

9.3.5 Alive Notification

[dts4132Alive]

Sent out in a configurable interval.

This *Notification* is always sent out, as soon as SNMP and the alarm traps are activated and a destination address is configured.

The *Notification* sent out contains the following data:

| Field | Type | Size | Description | Example |
|------------------|--------------|---------|--|--|
| dts4132SysStatus | Unsigned Int | 4 Bytes | Contains the internal system status | 66309 |
| dts4132SysAlarms | Byte Array | 8 Bytes | 64 Bit Alarm flags 1.Byte Bit 0..7 2.Byte Bit 8..15 :: 8.Byte Bit 56..63 | FFF870FF.FFFFFFFF 5.Byte 2.Byte 1.Byte |

9.3.6 Alarm Notification

[dts4132Alarm]

Sent out if alarm status changes, i.e. *Notification* is sent out when an alarm flag is set or deleted.

This *Notification* is always sent out, as soon as SNMP and the alarm traps are activated and a destination address is configured.

The *Notification* sent out contains the following data:

| Field | Type | Size | Description | Example |
|----------------------------|--------------|----------|--|------------------|
| dts4132TrapAlMsgErrorNr | Byte | 1 Byte | No. of the alarm bit (0..63) | 3 |
| dts4132TrapAlMsgErrorState | Byte | 1 Byte | 0 = alarm bit was deleted 1 = alarm bit was set | 1 |
| dts4132TrapAlMsgErrorTime | Unsigned Int | 4 Bytes | PC-time in seconds since 01.01.1970 00:00:00 | 946684805 |
| dts4132TrapAlMsgErrorText | Text | 59 Bytes | Error text | Failure supply 1 |

10 Description of the switch function

10.1 General Description

The switch program is composed of 99 week programs and 64 channel programs.

The week programs describe the behaviour during one week, independent of date and channel number. Such a week program can contain numerous lines and each line is composed of time of the day, days of week as well as the switching function to be executed at this moment.

The 3 possible switching functions are: ON, OFF, Signal 01 – 99 Seconds.

Now the channel programs assign the week programs to the channels, which are dependent on the date. Such a channel program can contain several lines. Each line is composed of the starting date and the number of the week program to be used.

Up to 1000 lines can be programmed in this way. This is the total sum of the lines in the week and channel programs.

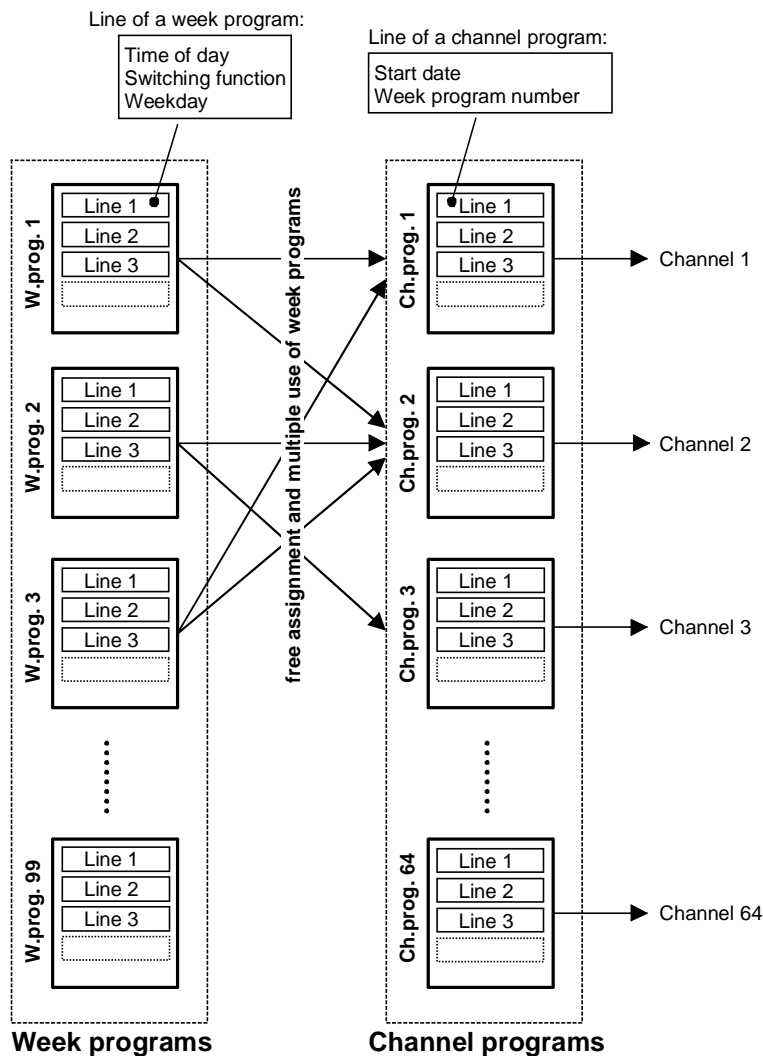

With the PC software "SwitchEditor" the switch programs can be created on a PC and then be downloaded to the DTS 4132 via FTP / USB stick or MOBA-NMS.

A maximum of **8 characters** are allowed for the file name of the **switch program file** and its extension is **PRG, Prg or prg**.

Additionally the SwitchEditor project file (mbs3) can be stored on the DTS.

10.2 Combination of the signals

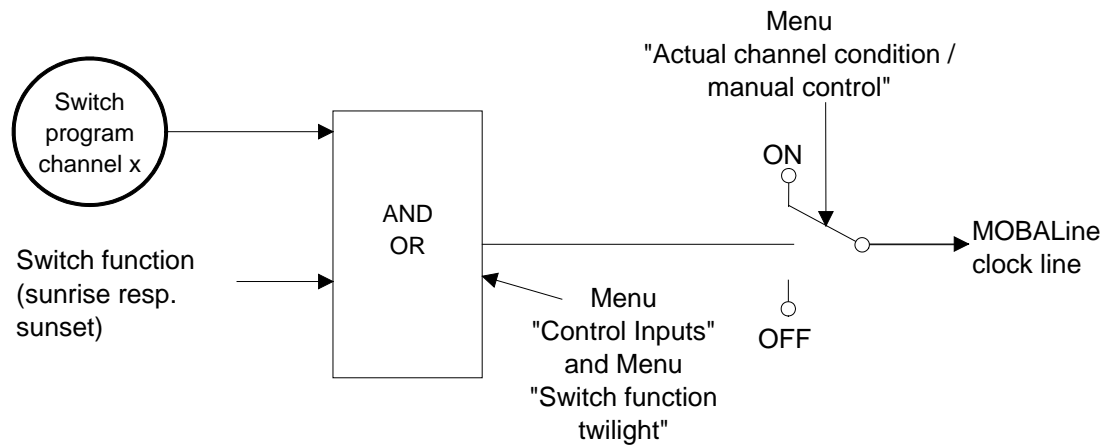

10.3 Behavior at start-up, exchange of switch program file

After starting up the DTS 4132, or after changing the program file, it can take up to 2 min until the switch states to the channel relay are correct.



Important: The max. number of signal commands is limited to 15 per minute.

11 Power supply alternatives

The DTS 4132.timeserver provides 3 different power supply alternatives:

1. Mains supply with 90 – 240 V / 50 - 60 Hz



Notice: In the menu: '2 Configuration' → '4 General' → '3 Power' must be set to '0=single'.

2. DC power supply with 24VDC +20% / -10% to DC in 1 or DC in 2



Notice: In the menu: '2 Configuration' → '4 General' → '3 Power' must be set to '0=single'.

3. Redundant power supply with the following variants:

| | Supply1: | Supply2: |
|-----------|-----------------|-----------------|
| Variant 1 | Mains supply | DC in 2 |
| Variant 2 | DC in 1 | DC in 2 |

Supply is checked once per minute for correct functioning. The alarm 'loss of power 1' or 'loss of power 2' is set in case of error.



Notice: In the menu: '2 Configuration' → '4 General' → '3 Power' must be set to '1=redundant'.

Block diagram of power supply:

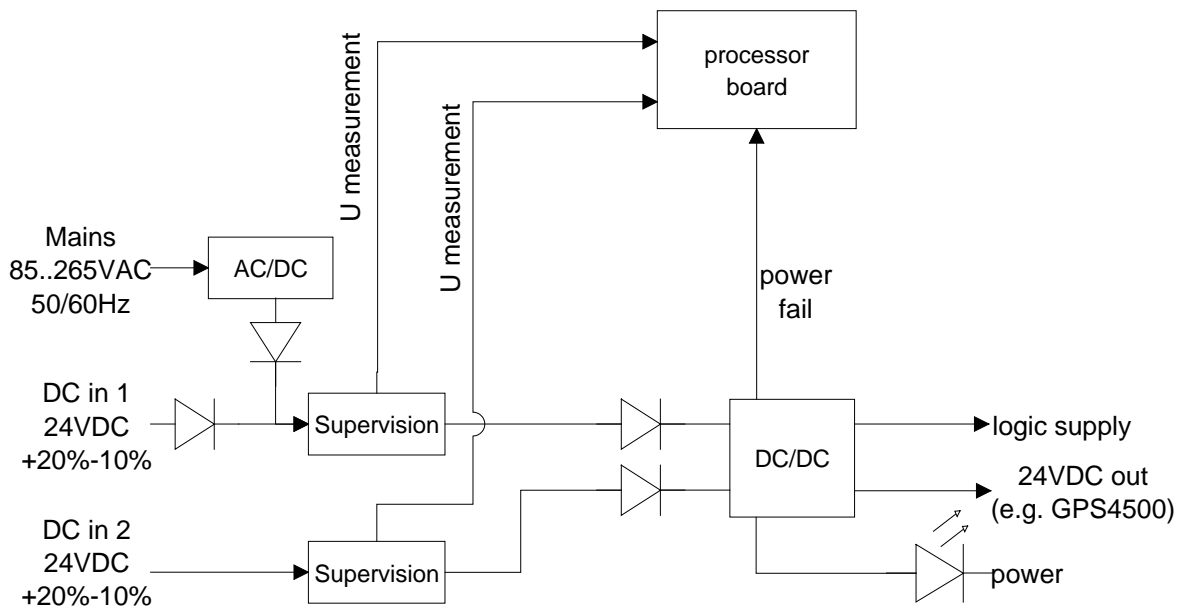

The mains supply and the DC in 1 input are internally linked, but protected against "Back powering".

A Connection diagrams

A.1 Front connections



PC - Terminal Connection:

Type of connector: Sub-D 9p connector (male)
Interface: RS232
Baud rate: 38400 Bauds
Data Bits: 8
Parity: no
Stop Bit: 1
Flow control: no

Cable DTS 4132 – PC: Crossed cable, female – female connectors (null modem)
(DTE-DTE) Max. length of the connection 3m

Connections between connector 1 (SUB-D 9 / 1) and connector 2 (SUB-D 9 / 2)

| | SUB-D 9 / 1 | SUB-D 9 / 2 | |
|---------------------------------|-------------|-------------|---------------------------------|
| Receive Data * | 2 | 3 | Transmit Data |
| Transmit Data * | 3 | 2 | Receive Data |
| Data Terminal Ready | 4 | 1 & 6 | Data Set Ready & Carrier Detect |
| System Ground * | 5 | 5 | System Ground |
| Data Set Ready & Carrier Detect | 1 & 6 | 4 | Data Terminal Ready |
| Request to Send | 7 | 8 | Clear to Send |
| Clear to Send | 8 | 7 | Request to Send |

* At least needed connections.

LAN 1 connection:

Plug: RJ45
Interface: Ethernet, 10/100Mbit half- or full duplex
Use only shielded cables!

LAN 2 connection:

Plug: RJ45
Interface: Ethernet, 10/100Mbit half- or full duplex
Use only shielded cables!



Notice: If only one LAN interface is used, it always has to be LAN 1!

USB connection:

Plug: USB host



Notice: Only permitted for operations with a USB stick!

A.2 Connections (rear view)

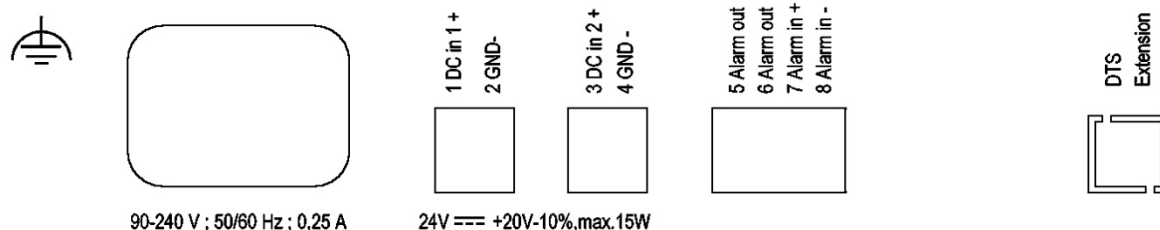

DTS 4132 connections

For technical data, see appendix “H Technical data”.

| Clamp | Connection | Description |
|---------------|--------------------------|--|
| | Earth connection | |
| L | Mains connection phase | Mains power input with rubber connector <i>Break point: by disconnecting the rubber connector</i> See Appendix H |
| | Mains connection earth | |
| N | Mains connection neutral | |
| 1 | DC in 1 power supply + | Input for external DC supply Ground |
| 2 | DC in 1 power supply GND | |
| 3 | DC in 2 power supply + | Input for external DC supply Ground |
| 4 | DC in 2 power supply GND | |
| 5 | Alarm relay | Alarm contact, open when alarm is active Max. load: 30 W (30 VDC or 1A) or 60 VA (60 VAC or 1A) |
| 6 | Alarm relay | |
| 7 | Alarm input + | Nominal 24 VDC, max. 100 mA Alarm input: e.g. for external closing contact between Alarm_in + and Alarm_in - . Or voltage input: 18-36 VDC, max. 6mA Voltage level “high” (24V available) or external contact closed → configurable: alarm or no alarm. |
| 8 | Alarm input - | |
| DTS extension | DTS extension | DTS extension bus |

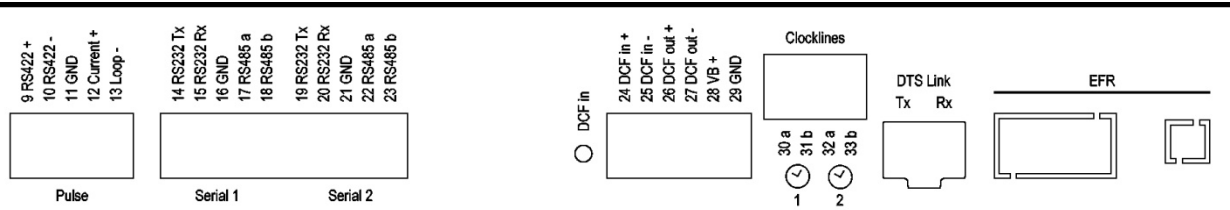

| Clamp | Connection | Description |
|-------|--------------------|---|
| 9 | RS422 + Pulse 1 | RS422 output line 1 for DCF, pulse and frequency output (internally the same source of signal like for the current loop output) |
| 10 | RS422 – Pulse 1 | |
| 11 | GND | |
| 12 | CL + Pulse 1 | Current loop line 1 for DCF, pulse and frequency output ("Current loop" passive, opto-coupler: $U_{max} = 50VDC$, $I_{max} = 10mA$) |
| 13 | CL – Pulse 1 | |
| 14 | RS232 Tx | RS232 interface of line 1 (Exclusive to the RS485 interface line 1; internally the same interface) |
| 15 | RS232 Rx | |
| 16 | GND | |
| 17 | RS485 A | RS485 interface of line 1 (Exclusive to the RS232 interface line 1; internally the same interface) |
| 18 | RS485 B | |
| 19 | RS232 Tx | RS232 interface of line 2 (Exclusive to the RS485 interface line 2; internally the same interface) |
| 20 | RS232 Rx | |
| 21 | GND | |
| 22 | RS485 A | RS485 interface of line 2 (Exclusive to the RS232 interface line 2; internally the same interface) |
| 23 | RS485 B | |
| 24 | DCF input + | DCF input e.g. for the connection of a GPS 4500 or DCF receiver with "current loop" output. |
| 25 | DCF input - | |
| 26 | DCF output + | DCF output, "current loop" passive, $U_{max} = 30VDC$, $I_{on} = 10..15mA$, $I_{off} < 1mA @ 20VDC$ |
| 27 | DCF output - | |
| 28 | DC output + (VB +) | DC output for GPS 4500 |
| 29 | DC output GND | 28 VDC, max. 100mA (or according to the DC in voltage) |
| 30 | Clock line 1 a | Output for MOBALine, impulse line 1 or DCF active line 1 |
| 31 | Clock line 1 b | Output for MOBALine, impulse line 1 or DCF active line 1 |
| 32 | Clock line 2 a | Output for MOBALine, impulse line 2 or DCF active line 2 |
| 33 | Clock line 2 b | Output for MOBALine, impulse line 2 or DCF active line 2 |
| | DTS Link | Optical connection to a 2nd DTS 4132 Mini GBIC plug-in |
| | EFR | Option, for special applications only |

A.3 Plug-in spring terminals

Multiple contact strip 100% protected against wrong plug;
 WAGO CAGE CLAMP®-connection
 Cross section of 0,08 mm² to 1,5 mm² (from AWG 28 to AWG 14)
 Voltage CSA 300 V / current CSA 10 A
 Rated voltage: EN 250 V
 Rated surge voltage: 2,5 kV
 Nominal current: 10 A
 Strip length: 7 mm (0,28 in)

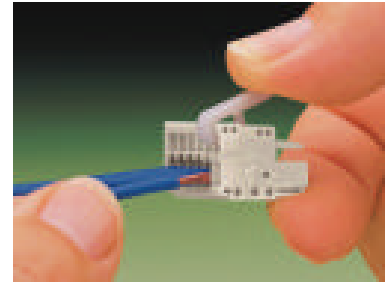

Pulled off spring terminal with operation tool:

2 operation tools are delivered with the accessory bag.

A.4 Connection GPS 4500, DCF 450 or GNSS 3000

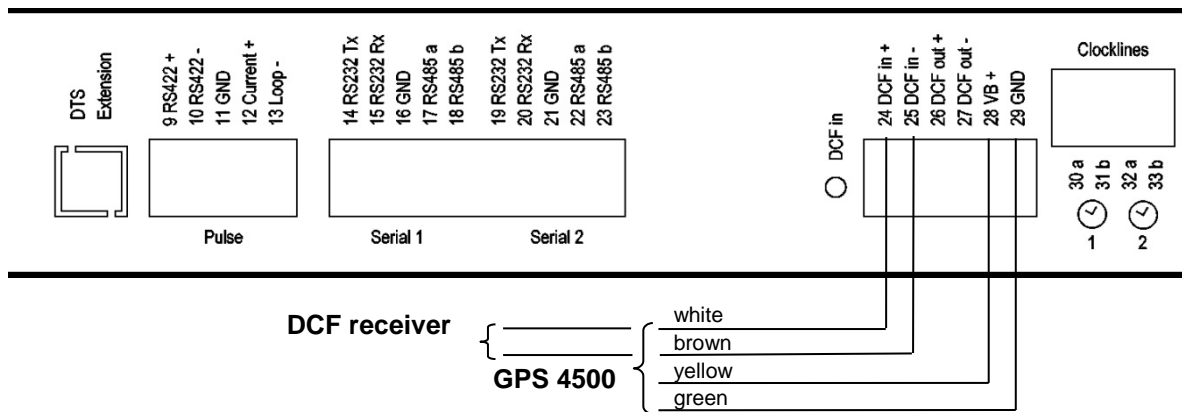

GNSS 3000 according to manual Bx-800813 chap. 9.2 Connection schematics DCF current loop

B Time zone table

Time zone entries in the standard season table (version 10.2).

| No. | City / State | UTC Offset | DST | Standard → DST | DST → Standard |
|-----|--|------------|-----|-----------------------------------|-----------------------------------|
| 00 | UTC (GMT), Monrovia | 0 | No | | |
| 01 | London, Dublin, Lisbon | 0 | Yes | Last Sun. Mar. (01:00) | Last Sun. Oct. (02:00) |
| 02 | Brussels, Amsterdam, Berlin, Bern, Copenhagen, Madrid, Oslo, Paris, Rome, Stockholm, Vienna, Belgrade, Bratislava, Budapest, Ljubljana, Prague, Sarajevo, Warsaw, Zagreb | +1 | Yes | Last Sun. Mar. (02:00) | Last Sun. Oct. (03:00) |
| 03 | Athens, Helsinki, Riga, Tallinn, Sofia, Vilnius | +2 | Yes | Last Sun. Mar. (03:00) | Last Sun. Oct. (04:00) |
| 04 | Bucharest | +2 | Yes | Last Sun. Mar. (03:00) | Last Sun. Oct. (04:00) |
| 05 | Pretoria, Harare, Kaliningrad | +2 | No | | |
| 06 | Amman | +2 | Yes | Last Thu. Mar. (23:59) | Last Fri. Oct. (01:00) |
| 07 | UTC (GMT) | 0 | No | | |
| 08 | Istanbul, Kuwait City, Minsk, Moscow, Saint Petersburg, Volgograd | +3 | No | | |
| 09 | Praia, Cape Verde | -1 | No | | |
| 10 | UTC (GMT) | 0 | No | | |
| 11 | Abu Dhabi, Muscat, Tbilisi, Samara | +4 | No | | |
| 12 | Kabul | +4.5 | No | | |
| 13 | Adamstown (Pitcairn Is.) | -8 | No | | |
| 14 | Tashkent, Islamabad, Karachi, Yekaterinburg | +5 | No | | |
| 15 | Mumbai, Kolkata, Chennai, New Delhi, Colombo | +5.5 | No | | |
| 16 | Astana, Thimphu, Dhaka, Novosibirsk | +6 | No | | |
| 17 | Bangkok, Hanoi, Jakarta, Krasnoyarsk | +7 | No | | |
| 18 | Beijing, Hong Kong, Singapore, Taipei, Irkutsk | +8 | No | | |
| 19 | Tokyo, Seoul, Yakutsk | +9 | No | | |
| 20 | Gambier Island | -9 | No | | |
| 21 | South Australia: Adelaide | +9.5 | Yes | 1 st Sun. Oct (02:00) | 1 st Sun. Apr. (03:00) |
| 22 | Northern Territory: Darwin | +9.5 | No | | |
| 23 | Brisbane, Guam, Port Moresby, Vladivostok | +10 | No | | |
| 24 | Sydney, Canberra, Melbourne, Tasmania: Hobart | +10 | Yes | 1 st Sun. Oct. (02:00) | 1 st Sun. Apr. (03:00) |
| 25 | UTC (GMT) | 0 | No | | |
| 26 | UTC (GMT) | 0 | No | | |
| 27 | Honiara (Solomon Is.), Magadan, Noumea (New Caledonia) | +11 | No | | |
| 28 | Auckland, Wellington | +12 | Yes | Last Sun. Sep. (02:00) | 1 st Sun. Apr. (03:00) |
| 29 | Majuro (Marshall Is.), Anadyr | +12 | No | | |
| 30 | Azores | -1 | Yes | Last Sun. Mar. (00:00) | Last Sun. Oct. (01:00) |
| 31 | Middle Atlantic | -2 | No | | |
| 32 | Brasilia | -3 | Yes | 3 rd Sun. Oct. (00:00) | 3 rd Sun. Feb. (00:00) |
| 33 | Buenos Aires | -3 | No | | |
| 34 | Newfoundland | -3.5 | Yes | 2 nd Sun. Mar. (02:00) | 1 st Sun. Nov. (02:00) |
| 35 | Atlantic Time (Canada) | -4 | Yes | 2 nd Sun. Mar. (02:00) | 1 st Sun. Nov. (02:00) |
| 36 | La Paz | -4 | No | | |
| 37 | Bogota, Lima, Quito | -5 | No | | |
| 38 | New York, Eastern Time (US & Canada) | -5 | Yes | 2 nd Sun. Mar. (02:00) | 1 st Sun. Nov. (02:00) |

| | | | | | |
|----|-------------------------------------|------|-----|-----------------------------------|-----------------------------------|
| 39 | Chicago, Central Time (US & Canada) | -6 | Yes | 2 nd Sun. Mar. (02:00) | 1 st Sun. Nov. (02:00) |
| 40 | Tegucigalpa, Honduras | -6 | No | | |
| 41 | Phoenix, Arizona | -7 | No | | |
| 42 | Denver, Mountain Time | -7 | Yes | 2 nd Sun. Mar. (02:00) | 1 st Sun. Nov. (02:00) |
| 43 | Los Angeles, Pacific Time | -8 | Yes | 2 nd Sun. Mar. (02:00) | 1 st Sun. Nov. (02:00) |
| 44 | Anchorage, Alaska (US) | -9 | Yes | 2 nd Sun. Mar. (02:00) | 1 st Sun. Nov. (02:00) |
| 45 | Honolulu, Hawaii (US) | -10 | No | | |
| 46 | Midway Islands (US) | -11 | No | | |
| 47 | Mexico City, Mexico | -6 | Yes | 1 st Sun. Apr. (02:00) | Last Sun. Oct. (02:00) |
| 48 | Adak (Aleutian Is.) | -10 | Yes | 2 nd Sun. Mar. (02:00) | 1 st Sun. Nov. (02:00) |
| 49 | UTC (GMT) | 0 | No | | |
| 50 | UTC (GMT) | 0 | No | | |
| 51 | UTC (GMT) | 0 | No | | |
| 52 | UTC (GMT) | 0 | No | | |
| 53 | UTC (GMT) | 0 | No | | |
| 54 | Ittoqqortoormiit, Greenland | -1 | Yes | Last Sun. Mar. (00:00) | Last Sun. Oct. (01:00) |
| 55 | Nuuk, Qaanaaq, Greenland | -3 | Yes | Last Sat. Mar. (22:00) | Last Sat. Oct. (23:00) |
| 56 | Not used | | | | |
| 57 | Western Australia: Perth | +8 | No | | |
| 58 | Caracas | -4.5 | No | | |
| 59 | CET standard time | +1 | No | | |
| 60 | Not used | | | | |
| 61 | Not used | | | | |
| 62 | Baku | +4 | Yes | Last Sun. Mar. (04:00) | Last Sun. Oct. (05:00) |
| 63 | UTC (GMT) | 0 | No | | |
| 64 | UTC (GMT) | 0 | No | | |

In countries where the DST switch date changes annually (e.g. Iran, Israel), the time zone has to be defined manually in the user time zone table (entries 80 – 99).

Legend:

UTC: Universal Time Coordinate, equivalent to GMT
DST: Daylight Saving Time
DST Change: Daylight Saving Time changeover
Standard → DST: Time change from Standard time (Winter time) to Summer time
DST → Standard: Time change from Summer time to Standard time (Winter time)

Example:

2nd last Sun. Mar. (02:00) Switch over on the penultimate Sunday in March at 02.00 hours local time.



Important:

The Time Zone Table is usually updated as needed. The current table is available for download under the following address: www.mobatime.com → Customer Area → Customer Support → Support Resources → Time Zone Table. In case your device is equipped with a newer version than shown in this manual, the current time zone settings should be checked.

Modifications / updating the time zone table:

In the DTS device the time zone tables are stored in the files */etc/mbsn.tbl* (standard table) and */etc/usersn.tbl* (user table).

The user table can be changed with Moser-Baer AG software such as ETCW or MOBA-NMS. Using MOBA-NMS, it can be downloaded from there, otherwise, it must be copied on to the DTS 4132 in accordance with the update instructions (chapter “7.3 Updating applications or configurations with FTP”).



Notice:

The file names *mbsn.tbl* and *usersn.tbl* must be written in small letters.

C Alarm list

| Number | Error message | Description / Action | Chap. |
|--------|------------------------|---|-----------|
| 0 | Reboot DTS | DTS 4132 restarted, no intervention required | |
| 1 | Error bit1 | Not used | |
| 2 | Supply voltage too low | Power failure (internally measured) → support | |
| 3 | Failure supply 1 | Power failure 1 (only if redundant supply is on) | |
| 4 | Failure supply 2 | Power failure 2 (only if redundant supply is on) | |
| 5 | Error voltage 5V | Power failure (internally measured) → support | |
| 6 | Error voltage 2.5V | Power failure (internally measured) → support | |
| 7 | Error voltage 1.25V | Power failure (internally measured) → support | |
| 8 | Wrong time zone DCF | Check DCF configuration | 6.5.2 |
| 9 | Error Time Zone TC | Check TC configuration (DCF/Impulse) | 6.5.3 / 5 |
| 10 | Error bit10 | Not used | |
| 11 | Alarm input | Error from external device | 6.5.21 |
| 12 | Line 1 current high | Check MOBALine / Impulse line / DCF active line. Alarm disappears only, if error is removed. | |
| 13 | Error time zone line 1 | Check time zone setting in (MOBALine / Impulse line / DCF active line) | |
| 14 | Line 2 current high | Check MOBALine / Impulse line / DCF active line. Alarm disappears only, if error is removed. | |
| 15 | Error time zone line 2 | Check time zone setting in (MOBALine / Impulse line / DCF active line) | |
| 16 | Time source fail strat | Stratum too high: check time source | 6.5.11 |
| 17 | Failure time source TO | No time information from the selected time source within the configured timeout: Check time source. In slave mode: check link. | 6.5.11 |
| 18 | No valid time | 20 min after starting no valid time → Check time source | |
| 19 | NTP synch lost | Check NTP source | |
| 20 | Error software trim | Quartz error or poor source quality | |
| 21 | NTP failed | Check NTP configuration | |
| 22 | NTP backup active | Check primary source | |
| 23 | Syn. only diff too big | Check synchronization and source | 6.5.12 |
| 24 | No mail server | Check e-mail configuration, check connection | 6.5.19 |
| 25 | SNMP not running | Check SNMP and trap configuration | 6.5.20 |
| 26 | Error bit26 | Not used | |
| 27 | Error bit27 | Not used | |
| 28 | Error bit28 | Not used | |
| 29 | Error bit29 | Not used | |
| 30 | No DTS link (optical) | No connection via DTS link (optical link) in redundant operation. Check connection. | |
| 31 | No DTS link (LAN) | No connection via LAN link in redundant operation. Check LAN connection. | |
| 32 | Change slave->master | Switch over slave -> master has occurred. Optionally, check the time source of current slave. | |

| | | | |
|----|------------------------|--|--------|
| 33 | Offset source (slave) | In slave mode only: check time sources Difference between slave and local time source too large | 6.5.13 |
| 34 | Fail local source | In slave mode only: check time sources | 6.5.11 |
| 35 | Error bit35 | Not used | |
| 36 | Error bit36 | Not used | |
| 37 | Error bit37 | Not used | |
| 38 | Tele.-file invalid | Check telegram file: the file name is longer than 8 digits or the file type is not TEL, Tel or tel; alternatively, syntax error in telegram file | 6.5.4 |
| 39 | Wrong time zone serial | Check serial time zone configuration | 6.5.4 |
| 40 | Error bit40 | Not used | |
| 41 | Error bit41 | Not used | |
| 42 | Error bit42 | Not used | |
| 43 | Error bit43 | Not used | |
| 44 | Error bit44 | Not used | |
| 45 | Error bit45 | Not used | |
| 46 | Error bit46 | Not used | |
| 47 | Error bit47 | Not used | |
| 48 | Error bit48 | Not used | |
| 49 | Error bit49 | Not used | |
| 50 | Error bit50 | Not used | |
| 51 | Error bit51 | Not used | |
| 52 | Error bit52 | Not used | |
| 53 | Error bit53 | Not used | |
| 54 | Error bit54 | Not used | |
| 55 | Error bit55 | Not used | |
| 56 | Error bit56 | Not used | |
| 57 | Error bit57 | Not used | |
| 58 | Error bit58 | Not used | |
| 59 | Error bit59 | Not used | |
| 60 | Error bit60 | Not used | |
| 61 | Error bit61 | Not used | |
| 62 | Error bit62 | Not used | |
| 63 | Error bit63 | Not used | |

D Troubleshooting

| | Error | → | → | Solution / possible cause |
|----|--|--|--|---|
| 1 | DTS does not accept time | Does the reading change (approx. every 3 sec) <i>Sec counter DCF</i> in <i>Status</i> → <i>Source</i> → TIME SOURCE INFORMATION? | No, but 20 min. have not yet passed since the last reboot. | After new installation or powers supply failure, it may take up to 20 min. until the GPS receiver (e.g. GPS 4500) sends out valid telegrams. Wait for this time to pass. |
| 2 | | | No, for more than 20 minutes. | <ul style="list-style-type: none"> • Check DCF reception LED • Check polarity cabling to GPS. • Check positioning of the GPS receiver |
| 3 | | Error-Bit 23 (<i>Syn only diff too big</i>) in <i>Status</i> → <i>Alarm status</i> set | | <p>The deviation to the received time is beyond the maximal allowed time correction.</p> <p>In the menu <i>Configuration</i> → <i>Time administration</i> → <i>Time-keeping configuration</i> → TIME ADJUSTMENT CONFIGURATION, set the parameter <i>synch. only offset</i> (4) to 0 (=deactivated). The time is now adjusted independently of the deviation's extend. It is however recommended to set a limit in normal operation (default 800ms).</p> |
| 4 | | <i>Offset to source</i> in <i>Status</i> → <i>Time</i> → TIME INFORMATION AND STATUS always shows the same offset | | <ul style="list-style-type: none"> • If Error-Bit 23 set, see point 3 • The deviation is that big, that offset changes cannot be seen due to the displayed resolution. |
| 5 | | Configuration has just been changed | | In the case of configuration changes, particularly if the time configuration is concerned, it can take several minutes for the change to appear correctly. |
| 6 | Error-Bit 16 set (<i>time source fail stratum</i>) | | | See 1 |
| 7 | Error-Bit 17 set (<i>time source fail TO</i>) | | | See 1 |
| 8 | Error-Bit 23 set (<i>Syn only diff too big</i>) | | | See 1 |
| 9 | DTS 4132 is restarting continuously. | | | Check if the network settings are correct, especially the hostname and the gateway has to be configured (when no gateway is available, the own IP address can be used). |
| 10 | LAN LED (left one) is flashing orange. | No connection to the network. | | Check network cabling. |
| 11 | Opening the menu via Telnet is not possible or DTS 4132.time-server is not or no longer reachable via network. | | | <p>Check network settings in menu 2 Configuration → 5 Network (only possible with serial connection):</p> <ul style="list-style-type: none"> - IP-Address, Subnet mask and Gateway must be set correctly - Interface should be set to Auto - Check connection with "Ping" - When earlier the menu was not correctly exited (e.g. LAN cable removed), the menu can be blocked up to 15 minutes. |
| 12 | Drift (ppm) of quartz too high | The drift displayed in the menu <i>Status</i> → <i>Time</i> → TIME INFORMATION AND STATUS is bigger than stated in the data sheet. | | <ul style="list-style-type: none"> • The quartz drift is measured and corrected continuously. After initial operation, it may take up to 24 hours until optimal accuracy is reached (with GPS reception). • Very large temperature change (outside the specification) • Time correction was carried out manually. |

| | | | |
|----|---|--|---|
| 13 | System software update | | <p>The system software can be updated using FTP client software or a USB stick (s. chapter 7 Updates).</p> <p>Your MOBATIME service informs you of use and necessity of a software update. If necessary, they can provide the needed firmware file.</p> |
| 14 | Needed information to contact your MOBATIME service | | <p>Device type, part number, production number and serial number:</p> <p>These details are given on the adhesive type label.</p> <p>If possible provide the following files for the analysis:</p> <p>All files from the directories <i>/var/log/</i> and <i>/etc/</i> and the file: <i>/ram/trim.log</i>.</p> <p>To copy this files use FTP, e.g. Windows Explorer with ftp://[IP address], see chapter 7.6.</p> <p>If the log files cannot be copied, please read out the current software version:</p> <p>The software version can be queried in the menu 1 STATUS/9 Versions of the software</p> <p>Place and date of purchase and of commissioning of the device.</p> <p>Most comprehensive possible details of the malfunction:</p> <p>Describe the problem, possible causes, measures taken, the system environment / operating mode and configuration, etc.</p> |

E Serial Telegrams

E.1 General

A serial interface can be used in two different modes:

- Send out time of telegrams automatically (periodically)
- Receive command, send time telegram (on request)

Output modes

Auto Periodic transmission of a time telegram or a command at the end of a second, minute, hour, or at a max. of 6 programmable times of the day, or definable output – periodicity.

on request Telegram is transmitted on request. The 'request' strings can be defined.

The following requests are possible:

- stop output
- output telegram at once (singly)
- output telegram at the next second (singly)
- output every second / minute / hourly / daily or switch to auto-mode.

Telegram format

Any character sequence. Fill characters ASCII or binary.

Variable display: ASCII decimal, ASCII hexadecimal or binary. Different variables are assigned to strings in text tables (e.g. month: Jan, Feb...). Syntax for the telegram string analogous to the print command in the programming language "C". See chapter E.2 Syntax of the telegram configuration file.

Telegram time

The telegram always contains the time information for the "next" second for periodical telegram output. The telegram content is valid at the send time of the first character. The send time of the telegram can be shifted with the parameter TC (e.g. the standard IF 482 telegram valid at the end of the telegram).

The transmission time of a time telegram can be calculated with the following table. According to the transmission format set, the transmission time in ms for one character is read from the table and multiplied by the number of telegram characters:

| parity | stopp byte | 7 data bits | | | | 8 data bits | | | |
|------------------------|------------|-------------|-------|----------|-------|-------------|-------|----------|-------|
| | | none | | odd/even | | none | | odd/even | |
| | | 1 | 2 | 1 | 2 | 1 | 2 | 1 | 2 |
| ms per transmited byte | | | | | | | | | |
| 300 | bit/s | 30.00 | 33.33 | 33.33 | 36.67 | 33.33 | 36.67 | 36.67 | 40.00 |
| 600 | bit/s | 15.00 | 16.67 | 16.67 | 18.33 | 16.67 | 18.33 | 18.33 | 20.00 |
| 1200 | bit/s | 7.50 | 8.33 | 8.33 | 9.17 | 8.33 | 9.17 | 9.17 | 10.00 |
| 2400 | bit/s | 3.75 | 4.17 | 4.17 | 4.58 | 4.17 | 4.58 | 4.58 | 5.00 |
| 4800 | bit/s | 1.88 | 2.08 | 2.08 | 2.29 | 2.08 | 2.29 | 2.29 | 2.50 |
| 9600 | bit/s | 0.94 | 1.04 | 1.04 | 1.15 | 1.04 | 1.15 | 1.15 | 1.25 |
| 19200 | bit/s | 0.47 | 0.52 | 0.52 | 0.57 | 0.52 | 0.57 | 0.57 | 0.63 |
| 38400 | bit/s | 0.23 | 0.26 | 0.26 | 0.29 | 0.26 | 0.29 | 0.29 | 0.31 |

Example:

9600 Bit/s, 8 data bits, none, 1 stop bit, the telegram has 20 characters.
Transmission time for the entire telegram:
20 x 1.04 ms = 20.8 ms

Name of the telegram file

The telegram file name is limited to 8 characters and its extension has to be TEL, Tel or tel, e.g. IF482Std.tel.

E.2 Syntax of the telegram configuration file

```
!TEL
    ;telegram type also !CTC or !MTS possible
;-- Start of the file (always on the first line) -----

;DEFINITIONS CONFIGURATION FILE FOR PRECISION MASTER CLOCK
;*****

;Customer:
;Date:
;Author:
;File:
;Interface:

;-- Output string -----
; the output string has a similar format to the print command in the
; programming language 'C'.
; !TS! - String with format information
; !TV! - Variables list in output sequence
; The formats and variables available can be seen below:
;
!TS!".....%d....%d..." ;String with Format information
!TV!var1,var2,... ;Variables list

;-- Control and special characters
; " -> String beginning/end
; \" -> "
; \xFE -> h'FE (Byte binary)
; \\ -> \
; \n -> new line <CR> <LF> (h'0D h'0A)
; %% -> %
; %... -> Format information (see below)

;-- Possible formats:
;%dn ascii-dez where n=1/2/3/4 (number of decimal points, max. 3 places received)
; e.g. variable value d'40 => 40 @ n=2
; => 040 @ n=3
;%X ascii-hex
; e.g. variable value d'40 => 28
;%c char (binary)
; e.g. variable value d'40 => h'28
;%s string (always up to,(comma) see text tables
; e.g. string Jan, => Jan
;%b hex-output of an asciihex-string (always up to(comma)see
; text tables
; e.g. string 120A, => h'12 h'0A

;-- Possible variables:
;
;Name: Description: Range: Format:
;-----|-----|-----|-----
;
;MSE (Millisecond) (0..999) 1W
;HSE (Hundredth of a second) (0..99) 1B
;ZSE (Tenth of a second) (0..9) 1B
;SEK (Second) (0..59) 1B
;MIN (Minute) (0..59) 1B
;STD (12h or 24h format) (0..12)
; or(0..24) 1B (see !PM!)
;JAR (Year) (0..99) 1W
; or (1990..2089)
```

```

;MTG (Day of the month) (1..31) 1B
;JTG (Day of the year) (1..366) 1W
;WTG (Day of the week) (0..6) 1W Text table !WT!
;
;(Su..Sa)
;DOW (Day of the week) (0..7) 1B !DW!
;KAW (Calendar week) (1..53) 1B (according to Din ISO 8601)
;MON (Month) (1..12) 1W Text table !MO!
;MNT (Month) (1..12) 1B
;
;
;AMF (am/pm flag) (0/1) 1W Text table !AM!
;TMQ (synchronization qual.) (0..255
; or A..Z) 1B (see !TQ!)
;SAI (Season) (0..2) 1W Text table !SA!
;
;(Win/Sum/UTC)
;AKS (Season change (0/1) 1W Text table !AK!
; announcement)
;AMF (am/pm-Flag) (0/1) 1W Text table !AM!
;SST (Season status) (0..3) 1W Text table !ST!
;
;(Bit 0 = Early warning bit)
;
;(Bit 1 = Summer bit)
;SYA (Synch. alarm) (0/1) 1W Texttable !SY!
;
;(0:synch ok, 1: synch alarm -> Alarm Nr.16, 17 or 19)
;CHS (Check sum) (0..255) 1B
;XCH (XOR Check sum) (0..255) 1B
;X1C (XOR Check sum low nibble in ASCII) (0..9, A..F) 1B
;X2C (XOR Check sum high nibble in ASCII) (0..9, A..F) 1B
;
; Definitions:
; CHS = (Sum of all bytes up to CHS) AND h'FF
; XCH = XOR link of all bytes up to CHS

;e.g. time telegram with following format (36 ASCII characters)
;
;"Date: tt:mm:yy Time: hh:mm:ss,mmm<CR><LF>"
;
;!TS!"Date: %d:%s:%d2 time: %d2:%d2:%d2,%d3\n"
;!TV!MTG,MON,JAR,STD,MIN,SEK,MSE
;-----

;-- Send offset automatic telegram output -----
!SO!hh:mm:ss!
;
;Send offset from midnight 00:00:00 at periodic time
;output (!CS!a!...).
;
;hh = hour ('00..23')
;mm = minute ('00..59')
;ss = second ('00..59')
;
;e.g. the periodic time output should start at 06:00:00
;
; in each case:
;
; !SO!06:00:00!
;
;-----

;-- Interval automatic telegram output -----
!TI!p!hh:mm:ss!
;
;Interval from send offset of the periodic time output.
;
;
;s = every second
;m = every minute
;h = hourly
;d!hh:mm:ss! daily (max. 6 entries)
;p!hh:mm:ss! constant
;hh = hour ('00..23')
;mm = minute ('00..59')
;ss = second ('00..59')
;
;e.g.1 telegram output every second
;
;!TI!s!
;
;e.g.2 telegram output daily at 13:00:00 hours
;
;!TI!d!13:00:00!
;
;e.g.3: the interval of the periodic time output should be 5 seconds:
;
;!TI!p!00:00:05!
;-----

```

```

/-- Hours format -----
!PM!
    ;Hours format 12h with am/pm flag
    ;without this entry: 24h format
;-----

/-- Synchronization mode -----
!TC!mmm!
    ;Pretiming of the telegram in ms (-90..995). To synchronize the telegram
    ;end with the second start the TC has to be set according to the telegram
    ;length and the transmission format. If TC is set, it will be performed.
    ;
    ;e.g. Telegram start 120ms before the start of the second:
    ;     !TC!120!
;-----

/-- Format time quality -----
!TQ!MAX VALUE!STEP!
    ;If this entry is absent, the byte value of TMQ is
    ;outputted
    ;MAX VALUE corresponds to the byte value for A
    ;MAX VALUE-STAGE corresponds to the byte value for B
    ;MAX VALUE-2*STAGE corresponds to the byte value for C ...

    ;Example: A for values >=120..101
    ;          B for values =100..81
    ;          C for values = 80..61 ...
    ;
    ;          !TQ!120!20!
;-----

/-- Command Strings -----
!CS!n!l!"ss..."! or !CS!n!l!"ss..."!
    ;
    ;n = Number of the command ('2...9')
    ;   n=2 Quit (no telegram output)
    ;   n=3 Telegram output immediately(singly)
    ;   n=4 Telegram output at the next second(singly)
    ;   n=5 Telegram every second
    ;   n=6 Telegram every minute
    ;   n=7 Telegram hourly
    ;   n=8 Telegram daily (-> entry: !TI!d!xx..)
    ;   n=9 Output command (Request for external time source)
    ;   n=a Telegram output periodic according to !TI!p! and !SO!
    ;
    ;l or  ll = Command length in bytes ('01...20')
    ;       l=0 Command not active
    ;
    ;ss... Command string
    ;       (max. 20 characters - must conform with 'l' or 'll')
    ;       Wildcards can be set with the '?' sign.
    ;       This serves as wildcard for any character.
    ;       Characters can also be outputted in AsciiHex format:
    ;       e.g.  \xFE    d.h <FE>=(h'FE) is inserted
    ;            \\      d.h '\ ' is inserted

    ;e.g. Definition of a commando for immediate telegram
    ;       output after a request (command n=3) :
    ;       'time<CR>' (characters ll=05)
    ;       !CS!3!05!"time?"!
    ;       !CS!3!5!"time\x0D"!
;-----

/-- Area for check sum calculation-----
!CK!aa,bb!
    ;aa = first character considered (telegram start position: 0)
    ;bb = last character considered + 1

;Missing !CK! in this case the check sum is formed via the whole telegram up to the
;check sum position.
;-----

```

```

;=====
;General info about the text tables:
; Name of the table: !xx!
; Separating character of the entries: , (comma)
; Maximal 16 characters pro Entry
; Warning: , do not forget(comma) after the last entry!
;=====

;-- Text table day of the week (WTG Su..Sa) 7 entries -----
!WT!Sunday,Monday,Tuesday,Wednesday,Thursday,Friday,Saturday,
;-----

;-- Weekday modus 1 entry -----
!DW!0..3
; 0 : 0 = Sunday, 1 = Monday,... 6 = Saturday
; 1 : 1 = Sunday, 2 = Monday,... 7 = Saturday
; 2 : 6 = Sunday, 0 = Monday,... 5 = Saturday
; 3 : 7 = Sunday, 1 = Monday,... 6 = Saturday
;-----

;-- Text table months (Jan..Dec) 12 entries -----
!MO!Jan,Feb,Mar,Apr,May,Jun,Jul,Aug,Sep,Oct,Nov,Dec,
;-----

;-- Text table season (Win,Som,UTC) 3 entries -----
!SA!Win,Som,UTC,
;-----

;-- Text table season change announcement -----
;-- (no announcement, announcement) 2 entries
!AK!0,1,
;-----

;-- Text table season status -----
;-- (0 = no announcement, winter
;-- 1 = announcement, winter
;-- 2 = no announcement, summer
;-- 3 = announcement, summer) 4 entries
!ST!A,B,C,D,
;-----

;-- Text table AM/PM flag 2 entries -----
!AM!am,pm,
;1.Entry AM/PM flag=0 d.h. 00:00..11:59
;2.Entry AM/PM flag=1 d.h. 12:00..23:59
;-----

;-- Text table synchronization alarm 2 entries -----
!SY!ok,alarm,
;1.Entry synchronization ok
;2.Entry synchronization s-failure
;-----

;-- File End ---
!EE!

;-- Name of the file (optional) ----
@nnn...
;nnn... File name, maximum 12 characters and a final
; <CR>. The name can also be omitted, in this
; case CTC 'NONAMEX.TEL'appears in the directory.
;
;IMPORTANT:
; 1) The name must stand AFTER the file end!EE!.
;
; 2) If a file with the same name is loaded on to the
; CTC, such as one stored on the CTC, the stored one
; will be OVERWRITTEN.
;
;
;e.g. !EE!
; @TELEDEF.TEL
; ;last line
;-----

;last line (guarantees a <CR> after the file name)

```

F Copyright Notice

All rights of the software remain the property of Moser-Baer AG.

Existing software (OpenSource) with their own licences were partly used:

| Designation | Description | Version | License | License Description (file) |
|-------------|--------------------|-----------|-------------------------------|----------------------------|
| U-Boot | Boot loader | 2009.08 | GPL version 2 | COPYING |
| Linux | Operating system | 3.2.0-rc3 | GPL version 2 | COPYING |
| Busybox | System environment | 1.19.3 | GPL version 2 | LICENSE |
| NTP | NTP | 4.2.8p12 | Free | COPYRIGHT |
| pure-ftp | FTP server | 1.0.35 | Free, partly BSD | COPYING |
| NetSNMP | SNMP agent | 5.8 | BSD | COPYING |
| OpenSSL | SSL Lib. | 1.1.1e | BSD style | LICENSE |
| OpenSSH | SFTP server | 5.9p1 | BSD | LICENSE |
| dropbear | SSH server | 2018.76 | MIT style: Free, party BSD | LICENSE |
| wide-dhcpv6 | DHCPv6 client | 20080615 | Free | COPYRIGHT |
| flex | Flex Lib. | 2.5.35 | BSD adapted | COPYING |
| zlib | Compress lib. | 1.2.5 | Free | README |
| mailsend | E-mail client | 1.15b5 | GPL | - |

The complete license descriptions can be referred to in the file indicated in the respective original source code on the corresponding project page.

Licence text GPL, BSD and MIT:

GPL version 2: <http://www.gnu.org/licenses/gpl-2.0.html>

BSD: <http://www.opensource.org/licenses/bsd-license.php>

MIT <http://www.opensource.org/licenses/with-license.php>

The source code of the open source projects running under GPL can be requested from Moser-Baer AG (support@mobatime.com). Handling costs will be charged!

G Parameters

| Group | Parameter | Acc | Default | Unit | SNMP |
|-------------------------|--|-----|-------------------------------------|---------|---|
| Network | 2 * Network | | | | dts4132Network (generally) dts4132Network1 (LAN 1) dts4132Network2 (LAN 2) |
| | DHCP on/off | RW | LAN 1: on LAN 2: off | | dts4132DHCPMode |
| | IP address | RW | LAN 1: dhcp LAN 2: 192.168.1.5 | | dts4132IPAddr |
| | Network mask | RW | LAN 1: dhcp LAN 2: 255.255.255.0 | | dts4132IPMask |
| | Gateway IP | RW | LAN 1: dhcp LAN 2: 192.168.1.1 | | dts4132IPGateway |
| | Name server IP | RW | LAN 1: dhcp LAN 2: | | dts4132IPNameserver |
| | Autoconf V6 | RW | off | | dts4132IPv6AutoConf |
| | DHCPv6 | RW | off | | dts4132IPv6DHCPMode |
| | IP address V6 1 | RW | 0::0 | | dts4132IPv6Addr1 |
| | IP prefix 1 | RW | 64 | | dts4132IPv6Prefix1 |
| | Gateway IPV6 1 | RW | 0::0 | | dts4132IPv6Gateway1 |
| | IP address V6 2 | RW | 0::0 | | dts4132IPv6Addr2 |
| | IP prefix 2 | RW | 64 | | dts4132IPv6Prefix2 |
| | Gateway IPV6 2 | RW | 0::0 | | dts4132IPv6Gateway2 |
| | Name server IPV6 | RW | 0::0 | | dts4132IPv6Nameserver |
| | Link 10/100Mbit | RW | auto | | dts4132EthernetLinkMode |
| | Device name / Host name | RW | DTS4132 | | dts4132Hostname, dts4132NetInfoHostname |
| | Domain | RW | | | dts4132Domain |
| Network Services | | | | | dts4132NetServices |
| | Telnet | RW | on | | dts4132TelnetMode |
| | SSH | RW | on | | dts4132SSHMode |
| | FTP | RW | on | | dts4132FTPMode |
| General | | | | | dts4132System |
| | Display language | RW | engl. | | dts4132Language |
| | Password user <i>dts</i> | RW | <i>dts</i> | | dts4132Password |
| | Time zone operation and alarm messages | RW | MEZ | | dts4132Timezone |
| | Redundant power supply | RW | off | | dts4132PowerSupply |
| Lines | | | | | dts4132OutputLines |
| DCF out | | | | | dts4132OutMainDCF |
| | Mode | RW | on | | dts4132OutMainDCFMode |
| | Time zone | RW | UTC | | dts4132OutMainDCFTimezone |
| NTP slave clocks | | | | | dts4132OutLineTZServer |
| | Mode | RW | off | | dts4132OutLineTZServerMode |
| | Multicast IP | RW | | | dts4132OutLineTZServerMCastAddr |
| | Multicast Port | RW | 65534 | | dts4132OutLineTZServerMCastPort |
| | Poll interval NTP | RW | 0 → 1sec | 2^x sec | dts4132OutLineTZServerNTPInterval |
| | Multicast TTL | RW | 1 | | dts4132OutLineTZServerTTL |
| | Table interval | RW | 60 | sec | dts4132OutLineTZServerTableInterval |
| | Entry interval | RW | 1 | sec | dts4132OutLineTZServerEntryInterval |
| | Table time zone entries | RW | -1 | | dts4132OutLineTZServerTable (TZ entry number) |
| DCF / Pulse out | | | | | dts4132OutLineDCFPulseFREQ |
| | Mode (off, DCF, pulse) | RW | 0 | | dts4132OutLineDCFMode |
| | Time zone | RW | UTC | | dts4132OutLineDCFTimezone |
| | Pulse interval (every second, minute...) | RW | sek | | dts4132OutLineDCFPulseType |
| | Pulse time | RW | 100 | ms | dts4132OutLineDCFPulseTime |
| | Pulse period | RW | 1 | sec | dts4132OutLineDCFPulsePeriod |
| | Output correction | RW | 0 | ms | dts4132OutLineDCFPulseCorrection |
| | Frequency | RW | 1000 | Hz | dts4132OutLineDCFFrequency |
| Serial out | | | | | dts4132OutLineSerial |
| | Mode (off, on) | RW | off | | dts4132OutLineSerialMode |
| | Time zone | RW | UTC | | dts4132OutLineSerialTimezone |

| | | | | | |
|----------------------------|--|----|-------------------------------------|---------|----------------------------------|
| | Telegram file | RW | MC482STD.TEL | | dts4132OutLineSerialTeleFile |
| | Interface: | RW | h'45 | | dts4132OutLineSerialComParam |
| | Baud rate | RW | 9600 | | |
| | Databit | RW | 7 | | |
| | Stopbit | RW | 1 | | |
| | Parity | RW | even | | |
| | Com mode | RW | out RS232 | | dts4132OutLineSerialComMode |
| E-mail | | | | | dts4132AlarmMailConfig |
| | Mode | RW | Off | | dts4132MailMode |
| | IP addr. mail server | RW | | | dts4132MailServerIPAddress |
| | Port mail server | RW | 25 | | dts4132MailServerPort |
| | Receiver address 1 | RW | | | dts4132MailAddrDestination1 |
| | Receiver address 2 | RW | | | dts4132MailAddrDestination2 |
| | Sender address ("login to mail server") | RW | | | dts4132MailAddrFrom |
| | Reply address | RW | | | dts4132MailAddrReply |
| | Error mask | RW | All set: FF FF FF FF FF FF FF FF | | dts4132MailAlarmMask |
| | Auth. Mode | RW | off | | dts4132MailAuthMode |
| | User name | RW | | | dts4132MailUser |
| | Password | RW | | | dts4132MailPassword |
| SNMP / - Traps | | | | | dts4132SnmConfig |
| | Trap mode | RW | off | | dts4132SnmTrapMode |
| | Trap community | RW | trapmobatime | | dts4132SnmTrapCommunity |
| | IP addr. target computer 1 | RW | | | dts4132SnmTrapListenerIPAddress1 |
| | Port target computer 1 | RW | 162 | | dts4132SnmTrapListenerPort1 |
| | Trap Version 1 | RW | V2c | | dts4132SnmTrapVersion1 |
| | IP addr. target computer 2 | RW | | | dts4132SnmTrapListenerIPAddress2 |
| | Port target computer 2 | RW | 162 | | dts4132SnmTrapListenerPort2 |
| | Trap version 2 | RW | V2c | | dts4132SnmTrapVersion2 |
| | TRAP error mask | RW | All set: FF FF FF FF FF FF FF FF | | dts4132SnmTrapAlarmMask |
| | TO alive message | RW | off | sec | dts4132SnmTrapAliveMsgInterval |
| | SNMP mode | RW | on | | dts4132SnmMode |
| | SNMP error mask | RW | All set: FF FF FF FF FF FF FF FF | | dts4132SnmAlarmMask |
| | Location | RW | | | dts4132SnmLocation |
| | Contact | RW | | | dts4132SnmContact |
| | rocommunity | RW | romobatime | | dts4132SnmROCommunity |
| | rwcommunity | RW | rwmobatime | | dts4132SnmRWCommunity |
| | 2*Access config: | | | | |
| | Password | RW | | | dts4132SnmV3UserPasswordx |
| | UserSecLevel | RW | 1+2: auth | | dts4132SnmV3UserLevelx |
| | UserRead | RW | 1+2: all | | dts4132SnmV3UserReadx |
| | UserWrite | RW | 1=dts1 2=dts2 | | dts4132SnmV3UserWritex |
| | View1 | RW | 1+2: .1.3.6.1.4.1.8072 | | dts4132SnmV3Viewx1 |
| | View2 | RW | 1+2: .1.3.6.1.4.1.2021 | | dts4132SnmV3Viewx2 |
| | View3 | RW | 1+2: .1.3.6.1.4.1.13842.4 | | dts4132SnmV3Viewx3 |
| | View4 | RW | 1+2: .2 | | dts4132SnmV3Viewx4 |
| | View5 | RW | 1+2: .2 | | dts4132SnmV3Viewx5 |
| | View6 | RW | 1+2: .2 | | dts4132SnmV3Viewx6 |
| Alarm input/output: | | | | | dts4132RelayAlarmConfig |
| | Error mask relay | RW | All set: FF FF FF FF FF FF FF FF | | dts4132RelayAlarmMask |
| | Mode alarm input | RW | | | dts4132AlarmInput |
| NTP / time handling | | | | | dts4132TimeHandling |
| Time source: | | | 2 (GPS, DCF) | | dts4132TimeSource |
| | Time source | RW | 0 (UTC) | | dts4132TSType |
| | Time zone | RW | 0 | | |
| | Config. stratum | RW | 50ms | Stratum | dts4132TSStratumMode |
| | Max. Time offset to set system time OK | RW | 60 | us | dts4132TSMaxOffsetForTimeValid |
| | TO time source for error failure synch (TO) | RW | 12 | min | dts4132TSTimeout |
| | Max. stratum for error failure synch (Stratum) | RW | 24 | Stratum | dts4132TSStratumErrorLimit |
| | TO time source stratum | RW | 50 | h | dts4132TSStratumTimeout |

| | | | | | |
|-----------------------------|--|----|---------|--------------|--|
| | Offset change to decrement stratum by 1 | RW | 0 | ms / stratum | dts4132TSOffsetPerStratum |
| | Source correction (DCF only) | RW | | ms | dts4132TSDCFAdjustment |
| Catch-up: | | | 1 (set) | | |
| | Catch-up mode | RW | 100ppm | | dts4132TSAAdjustmentMode |
| | Max. catch-up speed | RW | 0 | ns / sec | dts4132TSMMaxAdjustmentSpeed |
| | Core/Quartz type | RW | 0 (off) | | dts4132TSQuartzType |
| | Synch only offset | RW | 0 (off) | ms | dts4132TSOffsetSynchOnly |
| | RTC Mode | RW | 0 (off) | | dts4132TSRTCMode |
| | Leap second mode | RW | off | | dts4132TSLLeapSecMode |
| | Leap second date next correction | RW | | | dts4132TSLLeapSecDate |
| | | | | | |
| Redundant operation: | | | | | dts4132RedundantOp |
| | Mode redundant operation | RW | off | | dts4132RedOpMode |
| | Set manual master | RW | | | |
| | Max. stratum master in red. operation | RW | 16 | Stratum | dts4132RedOpSwitchOverStratum |
| | Max. time offset master to time source slave | RW | 100ms | us | dts4132RedOpMaxOffsetSlaveTimeSource |
| | IP addr. 2. time server | RW | | | dts4132RedOp2ndDTSIPAddress |
| | Port DTS LAN link communication | RW | 14338 | | dts4132RedOp2ndDTSIPPort |
| | | | | | |
| NTP: | | | | | dts4132TimeNTPServer |
| | 4 * NTP source | | | | dts4132NTPSourceTable (1..4) |
| | Addresses | RW | | | dts4132NTPSourceAddr |
| | Minpoll | RW | | 2^x sec | dts4132NTPSourceMinPoll |
| | Maxpoll | RW | | 2^x sec | dts4132NTPSourceMaxPoll |
| | Mode | RW | server | | dts4132NTPSourceMode |
| | Prefer (-red time source) | RW | normal | | dts4132NTPSourcePrefer |
| | Key | RW | off | | dts4132NTPSourceKey |
| | 2 * Broadcast: | | | | |
| | Broadcast address | RW | | | dts4132NTPBrodacstAddr |
| | Interval | RW | 2 → 4s | 2^x sec | dts4132NTPBroadcastInterval |
| | Multicast TTL | RW | 1 | | dts4132NTPBroadcastTTL |
| | Key | RW | off | | dts4132NTPBroadcastKey |
| | Trusted Keys | RW | | | dts4132NTPKeyTrusted |
| | Control Key | RW | 0 | | dts4132NTPKeyControl |
| | Request Key | RW | 0 | | dts4132NTPKeyRequest |
| | Autokey Password | RW | | | dts4132NTPAutokeyPassword |
| | | | | | dts4132NTPKeyGeneratorCmd |
| | | | | | dts4132NTPKeyFileCmd |
| | | | | | |
| Manual Time set | | | | | dts4132TimeManualSet |
| | Time | W | | | dts4132ManualTimeSetUTC |
| | Diff | W | | ms | dts4132ManualTimeSetDiff |
| | | | | | |
| Product Info | | | | | dts4132ProdInfo |
| | Prod. number | R | | | dts4132ProdInfoProdNo |
| | Article number | R | | | dts4132ProdInfoArticleNo |
| | HW revision | R | | | dts4132ProdInfoHWRevision |
| | HW code | R | | | dts4132ProdInfoHWCode |
| | HW name | R | | | dts4132ProdInfoHWName |
| | Firmware version | R | | | dts4132ProdInfoFirmwareVer |
| System Info | | | | | |
| | DTS state | R | | | dts4132SysStatus |
| | DTS alarms | R | | | dts4132SysAlarms |
| | Alarm relay state | R | | | |
| | SNMP alarms (masked) | R | | | |
| Trap Info | | | | | |
| | Trap state | R | | | |
| | Trap alarm number | R | | | |
| | Trap error state | R | | | |
| | Trap time | R | | | |
| | Trap message | R | | | |
| Time Info | | | | | dts4132SystemTimeInfo |
| | DTS stratum | R | | | dts4132TInfoStratum, dts4132SysStratum |
| | Last drift | R | | | dts4132TInfoLastDrift, dts4132SysLastDrift |
| | Last quartz corr | R | | | dts4132TInfoLastQCorr |
| | Act. corr. voltage | R | | | dts4132VoltageQuartzAdjust |
| | Current offset sec | R | | sec | dts4132DCFTInfoOffsetSec |

| | | | | | |
|-----------------------|-------------------------|---|--|----|--|
| | Current offset us | R | | us | dts4132DCFTInfoOffsetUsec, dts4132SysOffset |
| | Time of last time info | R | | | dts4132TInfoLastTime |
| | Jitter | R | | | dts4132TInfoSourceJitter |
| | Source quality | R | | | dts4132SysTimeReceptionQuality |
| | Offset of local source | R | | | |
| | Sample type | R | | | |
| | Source Type | R | | | dts4132SysTimeSource |
| | Last DCF time | R | | | dts4132DCFTInfoLastTime |
| | Last Link time | R | | | dts4132DCFTInfoLastLinkTime |
| | DCF pulse counter | R | | | dts4132DCFTInfoSecCount |
| | Link pulse counter | R | | | dts4132DCFTInfoLinkSecCount |
| | Red. State | R | | | dts4132SysMasterMode |
| | NTP source | R | | | dts4132NTPTInfoCurrentSource |
| | NTP offset | R | | | dts4132NTPTInfoSystemOffset |
| | NTP Jitter | R | | | dts4132NTPTInfoSourceJitter |
| | NTP Stratum | R | | | dts4132NTPTInfoStratum |
| | NTP Frequency | R | | | dts4132NTPTInfoFrequency |
| Versions | | | | | dts4132SystemVersions |
| | Version DTS application | R | | | dts4132verApplication |
| | Version DTS module | R | | | dts4132verTimeDriver |
| | Version FPGA module | R | | | dts4132verFPGADriver |
| | Version FPGA | R | | | dts4132verFPGA |
| | Version NTP | R | | | dts4132verNTP |
| | Version kernel | R | | | dts4132verLinux |
| | Version busybox (CLI) | R | | | dts4132verCLIShell |
| | Version rootfs | R | | | dts4132verRootFS |
| | Version language | R | | | dts4132verLangResource |
| | Version TZ table | R | | | dts4132verTimezoneTable |
| | Version snmp master | R | | | dts4132verSNMPMasterAgent |
| | Version snmp common | R | | | dts4132verSNMPSubAgent |
| | | | | | |
| Power Info | | | | | dts4132SystemPower |
| | Voltage 1 | R | | V | |
| | Voltage 1 | R | | mv | dts4132SupplyVoltage1 |
| | Voltage 2 | R | | V | |
| | Voltage 2 | R | | mv | dts4132SupplyVoltage2 |
| | Current 1 | R | | A | |
| | Current 1 | R | | mA | dts4132SupplyCurrent1 |
| | Current 2 | R | | A | |
| | Current 2 | R | | mA | dts4132SupplyCurrent2 |
| | | | | | |
| 2*Network Info | | | | | dts4132NetworkInfo |
| | IP v4 | R | | | dts4132NetInfoIPAddr |
| | GW v4 | R | | | dts4132NetInfoIPGateway |
| | Subnet v4 | R | | | dts4132NetInfoIPMask |
| | DNS v4 | R | | | dts4132NetInfoIPNameserver |
| | Hostname | R | | | |
| | Domain | R | | | dts4132NetInfoDomain |
| | DHCP | R | | | dts4132NetInfoDHCPMode |
| | Link | R | | | dts4132NetInfoEthernetLinkMode |
| | IP v6 link local | R | | | dts4132NetInfoIPv6AddrLocal |
| | IP1 v6 | R | | | dts4132NetInfoIPv6Addr1 |
| | IP2 v6 | R | | | dts4132NetInfoIPv6Addr2 |
| | GW v6 | R | | | dts4132NetInfoIPv6Gateway |
| | | | | | |
| Commands | | | | | dts4132SystemMaintenance |
| | Update cmd. | W | | | dts4132SysUpdateCmd |
| | Backup cmd. | W | | | dts4132SysBackupCmd |
| | Restore cmd | W | | | dts4132SysRestoreCmd |
| | Restore default cmd | W | | | dts4132SysDefaultCmd |
| | Restart cmd | W | | | dts4132SysRestartCmd |
| | Copy files cmd | W | | | dts4132SysCopyFiles |
| | Set all config changed | W | | | dts4132SysAllChanged |

H Technical data

| | | |
|---|--|---|
| Dimensions | 19" Rack, 1HU x 28PU (H x W x D [mm]) = 483 x 44 x 125 | |
| Weight | approx. 1.8 kg | |
| Ambient temperature | 0 to 60°C, 10-90% relative humidity, without condensation | |
| Operation | Telnet / SSH / MOBA-NMS (via LAN). In addition, operation is also possible with SNMP. | |
| Accuracy | GPS (DCF input) to NTP server: | typical < +/- 100 µs |
| | GPS (DCF input) to DCF output: | typical < +/- 10 µs |
| | NTP to internal time: | typical < +/- 100 µs |
| | GPS (DCF) input or NTP client to clock line: | typical < +/- 10 ms |
|  | Notice: | NTP reception (DTS 4132 as client or as server to external clients) can be influenced by the network traffic load and network devices (Hub, Switch, Router, Firewall...). |
| | | If many clients request simultaneously, the typical accuracy may not be reached. |
| Time keeping (internal) | Synchronized with GPS: | +/-10 µs to UTC |
| Holdover (free run): | After at least 12 hours synchronization from the time source: | |
| DTS 4132 -> TCXO: | at 20°C +/- 5°C: | < +/- 10 ms / day (< 0.1ppm) * |
| | at constant temperature: | < +/- 1 ms / day (< 0.01ppm) * |
| Generally: | During power break (based on internal RTC): | |
| | at 20°C +/- 5°C: | < 5 ppm, but with jitter of +/- 15 ms * |
| | After a power failure the RTC time is available during at least 5 days (RTC buffered through a SuperCAP). | |
| | *measured over 24 h | |
| Redundant operation | - Master to slave (optical DTS link): | typical < +/- 1 µs |
| Time server | NTP V4 | (fully V3 compatible), RFC 1305, RFC 5905 (Port 123) |
| | SNTP | (UDP), RFC 2030 (Port 123) |
| | TIME | (TCP/UDP), RFC 868 (Port 37) |
| | DAYTIME | (TCP/UDP), RFC 867 (Port 13) |
| | Max. number of NTP and SNTP client requests: > 1500 requests / sec. (e.g. client request every 60 sec. → >90'000 clients) | |
| NTP mode | Server, Peer, Broadcast, Multicast | |
| NTP slave clock lines: | 1 line with up to 15 different time zone entries. Communication through multicast: | |
| | -RFC 3376: Internet Group Management Protocol, Version 3 | |
| | -RFC 1112: Host extensions for IP multicasting | |
| | -RFC 4601: Protocol Independent Multicast - Sparse Mode (PIM-SM) | |
| | -RFC 3973: Protocol Independent Multicast - Dense Mode (PIM-DM) | |
| Time zones (see App. B) | Up to 80 predefined, 20 programmable entries (MOBA-NMS) | |
| 2 Network interfaces | 10BaseT / 100BaseTX (IEEE 802.3) | |
| | Data transmission rate: | Auto-negotiation / manual |
| | Connection: | RJ-45 |
| | Only shielded cables permitted. | |
| IP Configuration | DHCP, Static IP, IPv4, IPv6 | |

| | | | |
|--|--|----------------------------|----------------------------------|
| Network services | NTP | UDP, Port 123 | see timeserver |
| | SNTP | UDP, Port 123 | see timeserver |
| | TIME | TCP/UDP, Port 37 | see timeserver |
| | DAYTIME | TCP/UDP, Port 13 | see timeserver |
| | Telnet | TCP, Port 23 | operation |
| | SSH | TCP, Port 22 | operation |
| | SCP | via SSH | update |
| | SFTP | via SSH | update |
| | FTP | TCP, Port 21 | update |
| | SNMP | UDP, Port 161 | operation |
| | | UDP, Port selectable (162) | alarm notification, see SNMP |
| | SMTP | TCP, Port selectable (25) | alarm mail see E-Mail |
| | DHCP | UDP, Port 68 | dyn. address allocation (client) |
| | DNS | TCP/UDP, Port 53 | address resolution (client) |
| | DHCPv6 | only IPV6 | |
| | ECHO | ICMP | “Ping“ |
| SNMP | V1, V2c, V3 with MD5 for authentication and DES for encryption (privacy). | | |
| E-mail | Alarm reporting via SMTP. Authentication at the mail server: <ul style="list-style-type: none"> - with sender address - with username/password SMTP-Auth with LOGIN, PLAIN (RFC 4954) or CRAM-MD5 (RFC 2195) no “POP before SMTP“ possible | | |
| Serial interface (front side) | D-Sub 9 (male): (RS232, 38400, 8, n, 1, no flow control) Cable length: max. 3m | | |
| DCF input | DCF receiver or DCF from GPS, active current loop Time zone: selectable Nominal 28 VDC, max. 32mA, response threshold 8mA | | |
| Time signal outputs | NTP V4 for slave clocks (unicast and multicast) 1 x DCF current loop interface passive 2 x DCF, programmable impulse / frequency output over RS 422 and opto-coupler (current loop passive) 2 x Script files configurable time telegrams on RS 232, RS 422 (only send) and RS 485 2 x MOBALine / Impulse line / active DCF line (selectable) | | |
| DCF output (1x) | DCF time code, time zone selectable Max. time deviation with GPS source: +/- 10 µs, jitter < 10 µs DCF time code passive current loop interface: V _{max} = 30 VDC, I _{on} = 10..15 am, I _{off} < 0.1 mA @20VDC | | |
| DCF / impulse / frequency outputs (2x) | 2 lines for technical impulses: time zone selectable, output signal correction possible (DCF and impulse) Max. time deviation with GPS source: +/- 10 µs, Jitter < 10 µs Mode: <ul style="list-style-type: none"> - DCF time code - impulses: sec., min., h., or user-defined - frequency: 1Hz.. 5MHz (no square signal possible above 2MHz) 2 different electrical outputs with the same signal: <ul style="list-style-type: none"> - passive current loop output, opto coupler: I_{max.}=10 mA / U_{max.}=50 VDC - RS422 | | |
| Serial interface (2x) (back side) | 2 lines for telegram output RS232, RS422 or RS485 Max. time deviation to internal time: +/- 10 ms, Jitter < 10 ms 300-38400 Bauds, 7 or 8 Data bits, Parity: no, even, odd, Stop bit: 1 or 2, no flow control The description of the telegram function is provided in Appendix E. | | |

| | |
|--------------------------------------|--|
| MOBALine output (2x) | <p>Alternatively to the impulse clock line or DCF active line</p> <p>Max. current: up to 700 mA eff. (sum of both lines)</p> <p>Voltage: without load \approx 17 VAC, typical 15 VAC</p> <p>Line modes: 10 sec.-, ½ min.- or 1 min. steps</p> <p>Max. time deviation against internal time. +/- 10 ms</p> <p>MOBALine with switching function, switching function for clock illumination and World time function available.</p> <p>With DC power supply at least 28 VDC required</p> |
| Impulse line output (2x) | <p>Alternatively to the MOBALine clock line or DCF active line</p> <p>Max. current: up to 1000 mA impulse current (sum of both lines)</p> <p>Voltage: 24 VDC (polarized) (depending on power supply)</p> <p>Line modes: 1 min., ½ -min., 1/5-min., 1/8-min., 1 sec</p> <p>Impulse length: 200 – 30'000 ms, approx. 50 ms resolution</p> <p>Pause length: 200 – 30'000 ms, approx. 50 ms resolution</p> <p>Acceleration modes: 12 h, 24 h, 1 week</p> <p>Max. time deviation against internal time: +/- 1 ms</p> <p>With DC power supply at least 23.5 VDC required</p> |
| DCF active line (2x) | <p>Alternatively to the MOBALine clock line or impulse clock line</p> <p>Max. current: up to 1000 mA impulse current (sum of both lines)</p> <p>Voltage: 24 VDC (polarized) (depending on power supply)</p> <p>Line modes: See diagramm in chapter 6.5.8.</p> <p>Max. time deviation (pulse start) against internal time: +/- 1 ms</p> <p>With DC power supply at least 23.5 VDC required</p> |
| USB plug | USB host for USB stick |
| Alarm contact | <p>Opening relay contact (Alarm active → contact open).</p> <p>Breaking capacity: max. 30 W (DC) or 60 VA (AC) max. 60 VDC or 1 A / 30 VAC or 1 A</p> |
| Alarm reporting / Error reporting | <p>Alarm contact see Alarm contact</p> <p>E-mail see E-mail</p> <p>SNMP notification see SNMP trap</p> <p>Display see Display</p> <p>Alarm-LED -</p> |
| Alarm input | <p>18-36 VDC, max. 6mA, for external closing contact</p> <p>Function configurable</p> |
| DTS Link | <p>Plug-in position for mini GBIC module (GigaBit Interface Converter)</p> <p>1000Mbps, 3,3V (with LC connector)</p> <p>e.g. D-Link DEM-311GT, SX 850 nm, 1.25 Gbps/MM/3.3 V</p> <p>Maximal cable length depends on type of cable:</p> <ul style="list-style-type: none"> - Multimode fiber with a diameter of 50 μm: max. 550 m - Multimode fiber with a diameter of 62.5 μm: max. 275 m <p>With LX standard, longer cables can be achieved.</p> |
| Display | 2 lines with up to 16 characters for the display of status information. |
| DC power supply | 24 VDC +20% / -10% / max. 40 W |
| Mains power supply | 90 – 240 V / 50 - 60 Hz / 0.25 A |
| Power supply output | Nominal 24 VDC, max. 100 mA (respectively according to power supply) |

I Index

2

2 LAN Mode 41, 74

A

Accuracy 102
Alarm 51
Alarm configuration 46
Alarm input 51, 104
Alarm list 88
Alarm mask 47
Alarm relay 47, 104
Alarm status 13
Authentication 49, 71
Autoconf – Ipv6 55
Autokey 72

B

Baudrate 26
Baudrate – PC connection 82
Boot time 14
Broadcast NTP 44

C

Cable – PC connection 82
Channel program 79
Channel relay 35
Channel relay after start-up 80
Community (SNMP) 75
Configuration 23
Configuration – Backup 61
Configuration – Restore 61
Configuration – save 66
Connection table (to fill in) 107
Connections – alarm relay 83
Connections – DCF & GPS 85
Connections – PC 82
Connections - power supply 83
Connections – rear view 83
Connectors 85
Control Key 45
Copyright 97
CRAM-MD5 49

D

Data bit 26
Daylight Saving Time 87
DAYTIME 103
DC power supply 81, 83, 104
DCF – connection 85
DCF active 34
DCF input 84
DCF output 24, 84
DCF output – techn. data 103
Default values 14, 98
DES – Data Encryption Standard 71
Device link 41, 73, 84, 104
DHCP 54
DHCPv6 55

Display 13
Distributed Time System 10
DST 87

E

E-mail 48, 103

F

Factory settings 14, 61, 98
Firmware 13
FTP 55, 65, 103

G

GBIC 84, 104
GBIC Module 73
GNSS 3000 85
GPS 4500 85

I

Impulse line 32, 33
Impulslinie 32, 33, 35, 36, 38
Initial configuration 14
Interface 92
IPv4 configuration 54
IPv6 – FTP connection 65
IPv6 configuration 55

K

Key 71

L

Language setting 52
Leap second 71
Leap second mode 46
LED description front side 12
LED-Beschreibung Rückseite 12
Lines 24
Linux 16
Login (menu) 15

M

Mains supply 81, 83, 104
Maintenance 61
Manual time set 46, 69
MD5 71
Menu login 15
Menu structure 17
MIB files 75
mini GBIC 73, 84, 104
MOBALine 30
MOBA-NMS 10, 15, 18, 62, 87, 102
Multicast 28, 102
Multicast address 42
Multicast NTP 44

N

Network configuration 53
Network services 55, 102, 103

| | | | |
|-------------------------------------|-------------|-------------------------------|----------------|
| Notification | 76 | SNMP user configuration | 58 |
| NTP | 103 | SNTP | 103 |
| NTP as backup time source | 42, 70 | Software update | 62, 63 |
| NTP authentication | 45, 71 | Software version | 13 |
| NTP Autokey | 72 | Spring terminals | 85 |
| NTP broadcast | 44 | SSH | 16, 55, 103 |
| NTP mode | 102 | Standard settings | 14, 98 |
| NTP multicast | 44 | Start-up | 14, 80 |
| NTP server | 42 | Status menu | 20 |
| NTP slave clocks | 28, 102 | Stop bit | 26 |
| NTP symmetric keys | 71 | Stratum | 69 |
| NTP time source | 22, 43 | Sunrise time – calculated | 36 |
| NTP version | 70 | Sunset time – calculated | 36 |
| ntp.keys | 45 | Support | 91 |
| ntpq | 21 | Switch function | 35, 79 |
| O | | Switch program | 35 |
| Operation (menu) | 15 | Switch program – signal | 79 |
| Operation (MOBA-NMS) | 18 | SwitchEditor | 79 |
| Operation (SNMP) | 76 | T | |
| P | | Telegram – definition | 93 |
| Parameters | 98 | Telegram file | 26, 61, 67, 92 |
| Parity | 26 | Telnet | 16, 55, 103 |
| Password | 7, 15 | Terminal | 15 |
| Password configuration | 52 | TIME | 103 |
| Power setting | 52 | Time acceptance | 69 |
| Power supply | 81 | Time administration | 38, 68, 69 |
| Problem solving | 90 | Time server | 70, 102 |
| Program file | 35, 67, 79 | Time source – configuration | 39 |
| R | | Time source – time acceptance | 69 |
| Redundant NTP Multicast time server | 29 | Time zone | 86 |
| Redundant operation | 41, 73 | Time zone for displayed time | 52 |
| Request Key | 45 | Time zone selection | 60 |
| Restart | 14, 61 | Time zone server | 28 |
| RTC | 102 | Time zone table | 86 |
| RTC (Real Time Clock) | 68 | Time-keeping | 40, 69 |
| RTC mode | 40 | Transmission time | 92 |
| S | | Trap | 50, 76 |
| SCP | 66, 103 | Troubleshooting | 90 |
| Script file definition | 93 | Trusted Key | 45 |
| Season table | 86 | ttl (time to live) | 44 |
| Security - network | 7 | Twilight | 36, 37 |
| Serial connection | 16 | U | |
| Serial Interface – techn. data | 103 | Update | 91 |
| Serial telegrams | 26, 92 | Update – software | 62, 63 |
| SFTP | 65, 103 | Update time zone table | 87 |
| SMTP | 103 | USB | 61, 63, 64, 67 |
| SNMP | 10, 75, 103 | USB stick | 13, 14 |
| SNMP – alarm notification | 78 | UTC | 68, 87 |
| SNMP – alive notification | 78 | V | |
| SNMP – notification | 76 | Version | 13 |
| SNMP – operation | 76 | W | |
| SNMP access configuration | 59 | Week program | 79 |
| SNMP configuration | 50, 56 | World time | 28, 31 |
| SNMP traps | 50, 76 | World Time Function | 31 |

HEADQUARTERS / PRODUCTION

MOSER-BAER AG
Spitalstrasse 7, CH-3454 Sumiswald
Tel. +41 34 432 46 46 / Fax +41 34 432 46 99
moserbaer@mobatime.com / www.mobatime.com

SALES WORLDWIDE

MOSER-BAER SA EXPORT DIVISION
19 ch. du Champ-des-Filles, CH-1228 Plan-les-Ouates
Tel. +41 22 884 96 11 / Fax + 41 22 884 96 90
export@mobatime.com / www.mobatime.com

SALES SWITZERLAND

MOBATIME AG
Stettbachstrasse 5, CH-8600 Dübendorf
Tel. +41 44 802 75 75 / Fax +41 44 802 75 65
info-d@mobatime.ch / www.mobatime.ch

MOBATIME SA
En Budron H 20, CH-1052 Le Mont-sur-Lausanne
Tél. +41 21 654 33 50 / Fax +41 21 654 33 69
info-f@mobatime.ch / www.mobatime.ch

SALES GERMANY, AUSTRIA

BÜRK MOBATIME GmbH
Postfach 3760, D-78026 VS-Schwenningen
Steinkirchring 46, D-78056 VS-Schwenningen
Tel. +49 7720 8535 0 / Fax +49 7720 8535 11
buerk@buerk-mobatime.de / www.buerk-mobatime.de

